



MANN+HUMMEL Filters for Compressors and Vacuum Pumps



MANN+HUMMEL Group

The MANN+HUMMEL Group is an international company with its headquarters in Ludwigsburg, Germany. The group employs more than 10,000 people worldwide at more than 41 locations.

The company develops, produces and sells technically complex components and systems for the automotive

industry and many other fields. A key area is high quality filtration products for vehicles, engines and industrial applications. The OEM business with global market leaders and producers of vehicles, machines and installations defines the quality and performance of the products. Filters for the international aftermarket are sold

under a variety of international brands as well as under the MANN-FILTER brand.

MANN+HUMMEL Industrial Filters

The Industrial Filters Business Unit has its headquarters in Speyer, Germany. The business unit is specialized in meeting the special require-

ments of off-highway vehicles and engine applications, compressed air and vacuum technology, mechanical engineering and plant construction.

MANN+HUMMEL Industrial Filters offers high performance for these fields and other fields which have a requirement for the filtration and separation of air, gas and liquids.

Filters for many industrial fields

Modern, high performance vehicles, machines, devices and engines require filters and components with a correspondingly high performance. This documentation offers you an overview of our range of filters for compressors and vacuum pumps and the matching accessories – naturally in the accustomed MANN+HUMMEL OEM quality. Since our customers operate in many varied fields, such as

- construction machines
- agricultural machines
- compressors
- mechanical engineering
- engines and gear units
- commercial and customised vehicles, etc.

MANN+HUMMEL has extensive experience elaborating individual concepts and solutions for your special field of application.

Close to you

Production facilities and sales offices at various locations in Europe, America, South America and in Asia enable the clarification of technical questions locally. A subsidiary company or representative located near you means we are always available to offer you assistance.

How to find your contact partner:

If you are not yet in contact with MANN+HUMMEL or one of our representatives, please call

Tel.: +49 (62 32) 53-80

Fax: +49 (62 32) 53-88 99

and name your field of application. We will then pass you on to the appropriate sales team.

Information is also available in the internet at:
www.mann-hummel.com
E-Mail: if.info@mann-hummel.com

Contents

Company profile	Page 2
Product overview	Page 4
Air/oil separators	Page 7
Standard wrap elements	Page 10
Depth separator elements	Page 14
Air/oil separator boxes	Page 19
StarBox	Page 22
Air/oil separator filters	Page 23
Air/oil separators for vacuum pumps	Page 27
Accessories for air/oil separators	Page 35
Oil Filters and Fuel Filters	Page 41
Air Cleaners	Page 47
Technical Annex	Page 53
General information on air/oil separation	Page 54
Fitting and servicing information	Page 56
MANN+HUMMEL Quality	Page 57
List of contents according to part numbers	Page 59
Conversion Table	Page 62
Further information material (selection)	Page 63

Product overview

Standard wrap elements

Page 10

Application	Screw-type and sliding-vane compressors
Installation site	in pressure reservoir
Residual oil content in mg/m ³	1 to 3 mg/m ³
Operating temperature	120 °C
Pressure drop for a given nominal flow rate	0.17 bar
Available nominal flow rates	1 to 42 m ³ /min
Advantages	<ul style="list-style-type: none">• High process reliability by using top quality filtration media• Low oil consumption due to low residual oil content• Thoroughly tried and tested and reliable



Depth separator elements

Page 14

Application	Screw-type and sliding-vane compressors
Installation site	in pressure reservoir
Residual oil content in mg/m ³	1 to 3 mg/m ³
Operating temperature	120 °C
Pressure drop for a given nominal flow rate	0.2 bar
Available nominal flow rates	1 to 46 m ³ /min
Advantages	<ul style="list-style-type: none">• High process reliability by using top quality filtration media• Low oil consumption due to low residual oil content• Space saving achieved through compact design



Air/oil separator boxes

Page 19

Application	Screw-type and sliding-vane compressors
Installation site	upright on pressure reservoir
Residual oil content in mg/m ³	1 to 3 mg/m ³
Operating temperature	120 °C
Pressure drop for a given nominal flow rate	0.25 bar
Available nominal flow rates	1 to 6 m ³ /min
Advantages	<ul style="list-style-type: none">• High process reliability by using top quality filtration media• Simple and time-saving assembly and disassembly• Cost advantages with services as compared with traditional air/oil separators• Low oil consumption due to low residual oil content
Accessories	Screw-on connectors for oil extraction



Air/oil separator filters

Page 23

Application	Screw-type and sliding-vane compressors
Installation site	suspended in compressed air pipe
Residual oil content in mg/m ³	1 to 3 mg/m ³
Operating temperature	120 °C
Pressure drop for a given nominal flow rate	0.3 bar
Available nominal flow rates	1 to 16.5 m ³ /min
Advantages	<ul style="list-style-type: none">• High process reliability by using top quality filtration media• Simple and time-saving assembly and disassembly• Cost advantages with services as compared with traditional air/oil separators• Low oil consumption due to low residual oil content



Product overview

Air/oil separators for vacuum pumps

Page 27

Application	Oil-flooded slide vane rotary vacuum pumps
Installation site	in pressure reservoir
Residual oil content in mg/m ³	1 to 3 mg/m ³
Operating temperature	120 °C
Pressure drop for a given nominal flow rate	0.25 bar
Available nominal flow rates	0.1 to 3.6 m ³ /min
Advantages	<ul style="list-style-type: none">• High process reliability by using top quality filtration media• Low oil consumption due to low residual oil content



Accessories for air/oil separators

Page 35

- Seals
- Filter heads
- Screw-on connectors



Oil filters and fuel filters

Page 41

Detailed information is available in the MANN+HUMMEL catalogue for Liquid Filters (Order No. 19 942 10 101).



Air cleaners

Page 47

Detailed information is available in the MANN+HUMMEL catalogue for Air Cleaners (Order No. 19 941 10 101).





MANN+HUMMEL filters: economic and reliable

In a compressed air system air/oil separators, air cleaners and oil filters all work together closely. When one does not work properly, other filter systems installed downstream may well lose performance and service life.

The opposite is also true: perfect function of the filters has a positive effect on the process reliability and running costs of your compressed air system. Therefore, when selecting a filter it is critical to make the right decision. MANN+HUMMEL is the market leader for the development and manufacture of compressor filters and can offer you the security you need. The fine-tuned interaction of our air/oil separators, air cleaners and oil filters offers your compressor system ideal protection with a considerable increase in efficiency.

This is why all well-known compressor producers around the world work together with MANN+HUMMEL as a development partner and OEM supplier.

MANN+HUMMEL air/oil separators, air cleaners and oil filters offer you:

- the right quality of compressed air at all times
- a long service life for all compressor filter systems
- low oil and energy consumption
- optimum protection against wear in your compressed air system

Further information is available in the MANN+HUMMEL compressor animation available on DVD (Order No. 19 943 50 100) or CD-ROM (Order No. 19 943 50 200).

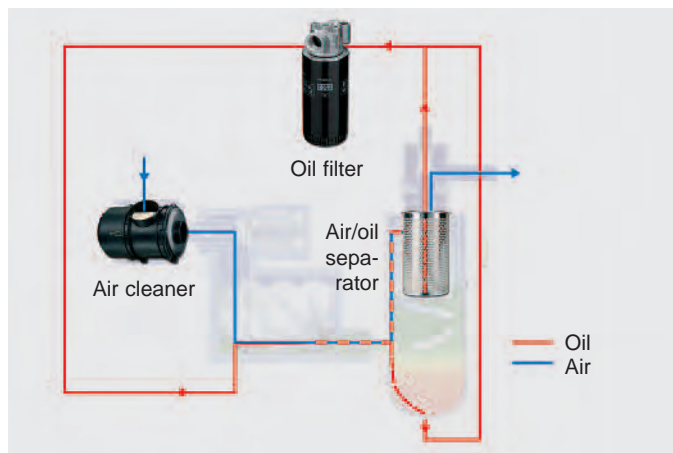

Perfect interaction in a compressed air system

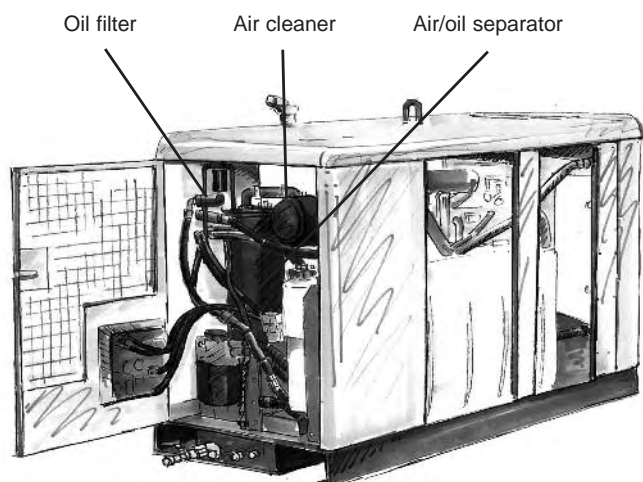



MANN+HUMMEL Air/oil separators

MANN+HUMMEL Air/oil separators

The use of compressed air is now an integral feature of every industrial firm. Compressors and vacuum pumps are used in the construction industry, mechanical engineering and in highly sensitive sectors such as the foodstuffs, pharmaceuticals and electrical engineering industries. Air/oil separators are important quality components in the compressed air processing chain.



Working principle

Air/oil separators work according to the „principle of coalescence“. Micro-glass-fibre layers separate drops of oil from the compressed air and return them in large drops to the oil circuit of the compressor. The separation process is effective right down to the submicron range. This ensures that oil consumption in the compressors

and oil entrainment into the compressed air networks are kept to a minimum. Oil-vapour is not separated. Air/oil separators can be used with all types of standard compressor lubricating oils, irrespective of whether they are mineral-based, synthetic or partially synthetic products.

Separation of oil drops

Depending on the size of the drops, various physical separation effects result in the fine drops being adsorbed by the micro-glass fibres. The number of fibres, fibre diameter and flow velocity have a major impact on separation efficiency. If the design is modified, interaction between inertia, capillaries and diffusion effects is optimised. The fine oil droplets are pressed through the separation medium and as they pass through they come together to form larger drops. Under the effect of gravity these droplets sink down through the secondary separation medium on the clean side. The correct choice of material in combination

with low flow resistance enables an almost complete separation and redirection of the oil droplets remaining in the air flow. This also applies to load fluctuations around the nominal utilisation point.

Return of separated oil

Depending on the design of compressor, oil is returned in a number of different ways. In the standard design of air/oil separators, oil flows from the outside to the inside and the drainage oil is drawn off on the dry side through a centrally positioned pipe running from the base cup of the separator.

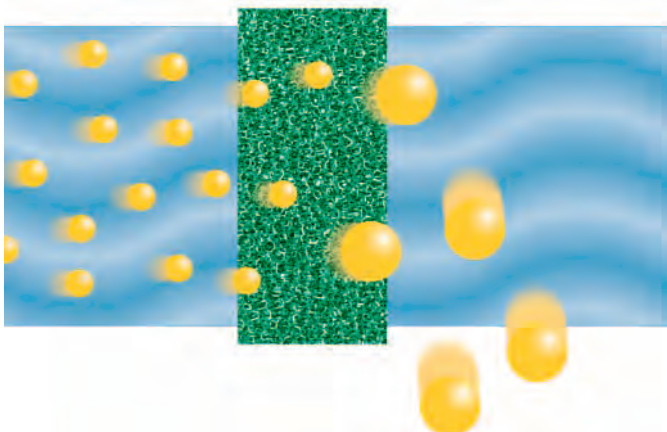

Oil separation according to the „principle of coalescence“

Design and working principle of air/oil separators

Design

Due to their design, air/oil separators are constructed with a number of layers. The fine separation layer made of borosilicate glass fibres with defined layer thicknesses is responsible for the coalescence effect.

These microfibre papers are almost free of binding agents and ensure stability with different lubricant types even at relatively high operating tem-

peratures. The redirection of the oil droplets is realised with a polyester fabric.

Under unfavourable pre-separation conditions in the pressure vessel a preseparator integrated in the element can protect the other two from overload. This can also lead to a longer service life of the air/oil separator. Elements with pre-separation are available on request.

In accordance with the requirements of the trade association of the chemical industry, the metal parts of air/oil separators for compressors have an electrically conductive interconnection in order to transfer any static charges reliably. Suitably prepared mounting seals produce conductive connections to the compressor housing.

Flow resistance

Depending on their type, air/oil separators have flow resistances of between 0.17 bar (17 KPa) and 0.22 bar (22 KPa), referred to the oil-moistened operating state at nominal volumetric flow and at operating temperature.

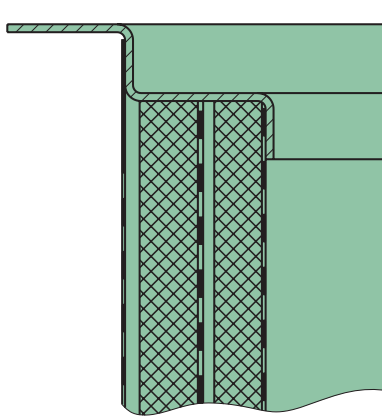

Air/oil separator element in the standard version

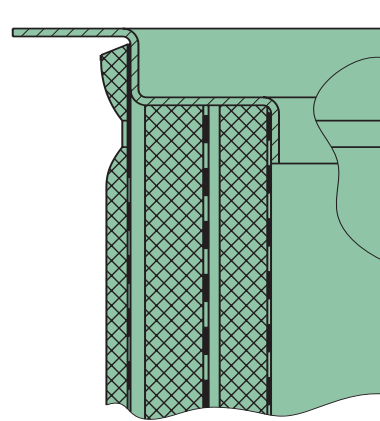

Air/oil separator element with pre-separation

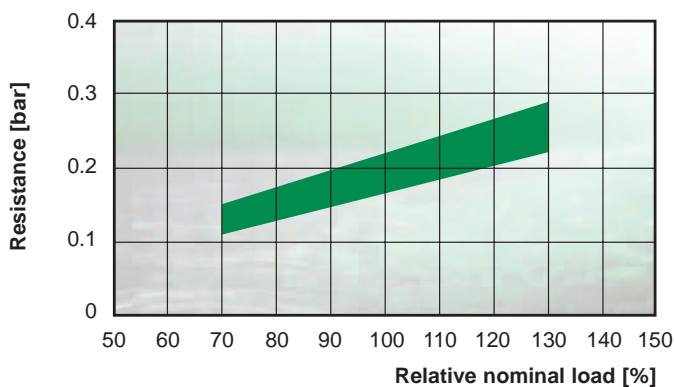

Flow resistances of air/oil separator elements

Advantages at a glance:

- High resistance to differential pressure
- Operating temperature: up to 120 °C
- Residual oil content: 1 to 3 mg/m³ or ppm (at nominal load)
- Nominal flow rates: (at 7 bar/0.7 MPa)
 - Standard wrap elements: 1 to 42 m³/min
 - Depth separator elements: 1 to 46 m³/min
 - Air/oil separator boxes: 1 to 6 m³/min
 - Air/oil separator filters: 1 to 16.5 m³/min
 - Air/oil separators for vacuum pumps: 0.1 to 3.6 m³/min

MANN+HUMMEL Standard Wrap Elements



Fitting advice

Standard wrap elements are available in a variety of sizes. They will only function properly when there is no leakage between the wet and the dry sides. Air should be guided in such a way as to prevent the air/oil stream impacting directly on the surface of the filter element.

Design and function

This product is suitable for flow from the outside to the inside. It can be used for the entire range of current versions of screw-type and sliding vane compressors. The standard wrap elements are particularly insensitive to design variations and achieve optimal results with regard to separation efficiency and service life.

Pressure drop

The pressure drop at nominal flow rate and at 7 bar (0.7 MPa) operating pressure with a new element is 0.17 bar (17 KPa). If a higher resistance is permitted, the volumetric flow rate can be doubled without downgrading performance.

Pressure resistance

The standard wrap elements designed for pressure differences of at least 5 bar (0.5 MPa).



Separation efficiency

The residual oil content at nominal flow rate and at 7 bar (0.7 MPa) operating pressure is approximately 1 to 3 mg/m³.

Service life

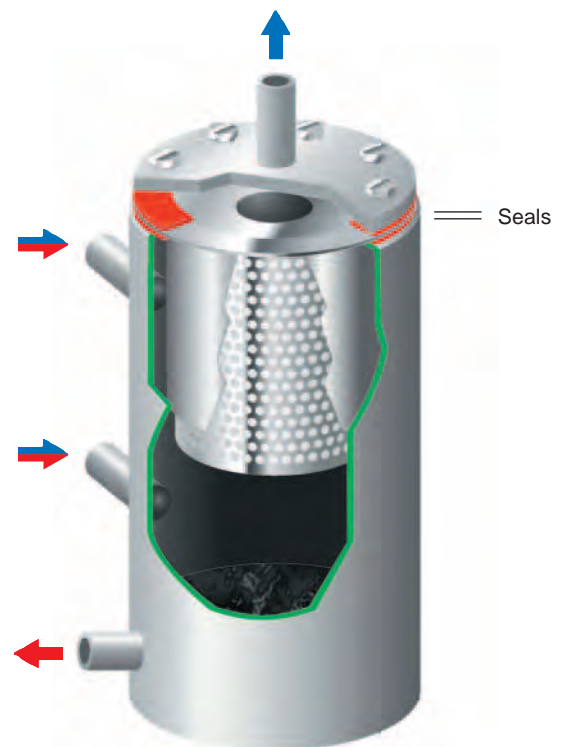
The rise in flow resistance and thus service life primarily depend on the cleanness of the oil and the quality of the air filter. A service life of several thousand hours can be achieved with a well-functioning system.



-  Compressed air inlets for oil saturated air (2 inlet alternatives)
-  to oil injection
-  oil-free compressed air

Installation of Standard Wrap Element in pressure reservoir

Dimensions and order numbers

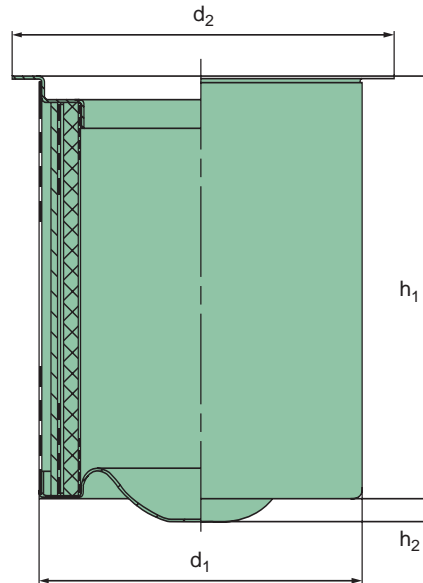

Order No.	Nominal flow rate ¹⁾ [m ³ /min] [cfm]	Dimensions in mm [<i>dimensions in inches</i>]				with seals
		d ₁	d ₂	h ₁	h ₂	
49 000 55 291	1.0 [35.31]	125 [4.92]	165 [6.50]	110 [4.33]	12 [0.47]	x
49 000 53 112	1.5 [52.97]	135 [5.31]	165 [6.50]	140 [5.51]	12 [0.47]	–
49 001 53 105	1.8 [63.57]	135 [5.31]	205 [8.07]	165 [6.50]	12 [0.47]	–
49 001 53 161	2.0 [70.63]	110 [4.33]	154 [6.06]	230 [9.06]	–	–
49 000 51 531	2.2 [77.69]	135 [5.31]	170 [6.69]	200 [7.87]	–	–
49 000 51 491	2.3 [81.22]	170 [6.69]	200 [7.87]	160 [6.30]	12 [0.47]	–
49 000 51 311	2.6 [91.82]	170 [6.69]	250 [9.84]	180 [7.09]	12 [0.47]	–
49 001 53 361	2.9 [102.41]	135 [5.31]	178 [7.01]	250 [9.84]	12 [0.47]	–
49 000 51 201	3.4 [120.07]	170 [6.69]	200 [7.87]	230 [9.06]	12 [0.47]	–
49 002 53 281	3.4 [120.07]	170 [6.69]	220 [8.66]	230 [9.06]	12 [0.47]	–
49 002 53 481	3.4 [120.07]	170 [6.69]	250 [9.84]	230 [9.06]	12 [0.47]	–
49 000 51 851	3.4 [120.07]	220 [8.66]	300 [11.81]	180 [7.09]	12 [0.47]	–

¹⁾ Flow rate according to DIN 1945 at 7 bar (0.7 MPa) operating pressure.
Specially adapted sizes are available on request.

Dimensions and order numbers

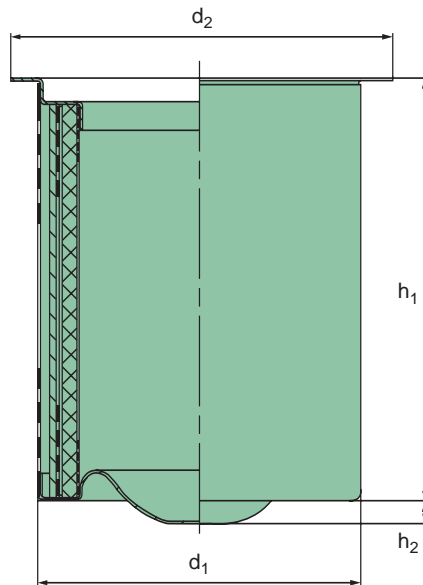

Order No.	Nominal flow rate ¹⁾ [m ³ /min] [cfm]	Dimensions in mm [<i>dimensions in inches</i>]				with seals
		d ₁	d ₂	h ₁	h ₂	
49 002 55 171	3.0 [123.60]	135 [5.31]	178 [7.01]	305 [12.01]	–	x
49 000 51 411	3.6 [127.13]	135 [5.31]	170 [6.69]	305 [12.01]	–	–
49 002 53 491	3.7 [130.66]	170 [6.69]	200 [7.87]	250 [9.84]	12 [0.47]	–
49 002 53 121	4.2 [148.32]	275 [10.83]	375 [14.76]	180 [7.09]	12 [0.47]	–
49 002 53 371	4.3 [151.85]	170 [6.69]	192 [7.56]	288 [11.34]	12 [0.47]	–
49 002 53 331	4.4 [155.38]	220 [8.66]	300 [11.81]	230 [9.06]	12 [0.47]	–
49 000 51 121	4.6 [162.45]	170 [6.69]	200 [7.87]	305 [12.01]	12 [0.47]	–
49 000 51 231	4.6 [162.45]	170 [6.69]	250 [9.84]	305 [12.01]	12 [0.47]	–
49 002 53 512	4.6 [162.45]	170 [6.69]	220 [8.66]	305 [12.01]	12 [0.47]	–
49 002 53 301	4.9 [173.04]	220 [8.66]	290 [11.42]	250 [9.84]	12 [0.47]	–
49 002 53 351	5.5 [194.23]	170 [6.69]	275 [10.83]	360 [14.17]	12 [0.47]	–
49 000 51 771	6.3 [222.48]	220 [8.66]	274 [10.79]	320 [12.60]	12 [0.47]	–
49 000 51 111	6.7 [236.61]	170 [6.69]	200 [7.87]	435 [17.13]	12 [0.47]	–
49 000 51 241	6.7 [236.61]	170 [6.69]	232 [9.13]	435 [17.13]	12 [0.47]	–
49 003 53 122	7.6 [268.39]	170 [6.69]	200 [7.87]	485 [19.09]	12 [0.47]	–

¹⁾ Flow rate according to DIN 1945 at 7 bar (0.7 MPa) operating pressure.
Specially adapted sizes are available on request.

Dimensions and order numbers

Order No.	Nominal flow rate ¹⁾ [m ³ /min] [cfm]	Dimensions in mm [<i>dimensions in inches</i>]				with seals
		d ₁	d ₂	h ₁	h ₂	
49 000 51 101	7.6 [268.39]	275 [10.83]	328 [12.91]	305 [12.01]	12 [0.47]	–
49 003 53 100	7.6 [268.39]	275 [10.83]	375 [14.76]	305 [12.01]	12 [0.47]	–
49 003 53 131	7.6 [268.39]	275 [10.83]	324 [12.76]	305 [12.01]	12 [0.47]	–
49 000 51 171	8.8 [310.77]	220 [8.66]	274 [10.79]	435 [17.13]	12 [0.47]	–
49 003 53 332	8.8 [310.77]	220 [8.66]	380 [14.96]	435 [17.13]	12 [0.47]	–
49 004 53 111	10.6 [374.34]	475 [18.70]	590 [23.23]	250 [9.84]	12 [0.47]	–
49 000 51 441	11.2 [395.52]	275 [10.83]	328 [12.91]	400 [15.75]	12 [0.47]	–
49 000 51 321	11.5 [406.12]	275 [10.83]	328 [12.91]	450 [17.72]	12 [0.47]	–
49 000 51 131	12.3 [434.37]	220 [8.66]	274 [10.79]	600 [23.62]	12 [0.47]	–
49 004 53 151	12.3 [434.37]	220 [8.66]	262 [10.31]	600 [23.62]	12 [0.47]	–
49 000 51 331	12.6 [444.96]	300 [11.81]	348 [13.70]	450 [17.72]	12 [0.47]	–
49 000 51 191	14.1 [497.94]	300 [11.81]	355 [13.98]	500 [19.69]	12 [0.47]	–
49 005 53 101	14.1 [497.94]	300 [11.81]	328 [12.91]	500 [19.69]	12 [0.47]	–
49 000 51 181	17.1 [603.88]	300 [11.81]	355 [13.98]	600 [23.62]	12 [0.47]	–
49 000 51 221	18.9 [667.45]	300 [11.81]	355 [13.98]	660 [25.98]	12 [0.47]	–
49 006 53 100	18.9 [667.45]	300 [11.81]	353 [13.90]	660 [25.98]	12 [0.47]	–
49 006 53 261	18.9 [667.45]	300 [11.81]	400 [15.75]	660 [25.98]	12 [0.47]	–
49 000 51 521	19.6 [692.17]	275 [10.83]	324 [12.76]	750 [29.53]	12 [0.47]	–
49 007 53 102	21.5 [759.27]	300 [11.81]	328 [12.91]	750 [29.53]	12 [0.47]	–
49 007 53 121	21.5 [759.27]	300 [11.81]	348 [13.70]	750 [29.53]	12 [0.47]	–
49 000 51 481	23.6 [833.43]	300 [11.81]	355 [13.98]	820 [32.28]	12 [0.47]	–
49 000 51 541	28.9 [1020.59]	300 [11.81]	355 [13.98]	1000 [39.37]	12 [0.47]	–
49 000 51 251	41.7 [1472.62]	475 [18.70]	740 [29.13]	900 [35.43]	20 [0.79]	–
49 000 51 581	41.7 [1472.62]	475 [18.70]	570 [22.44]	900 [35.43]	20 [0.79]	–
49 013 53 111	41.7 [1472.62]	475 [18.70]	590 [23.23]	900 [35.43]	20 [0.79]	–

¹⁾ Flow rate according to DIN 1945 at 7 bar (0.7 MPa) operating pressure.
Specially adapted sizes are available on request.

MANN+HUMMEL Depth Separator Elements

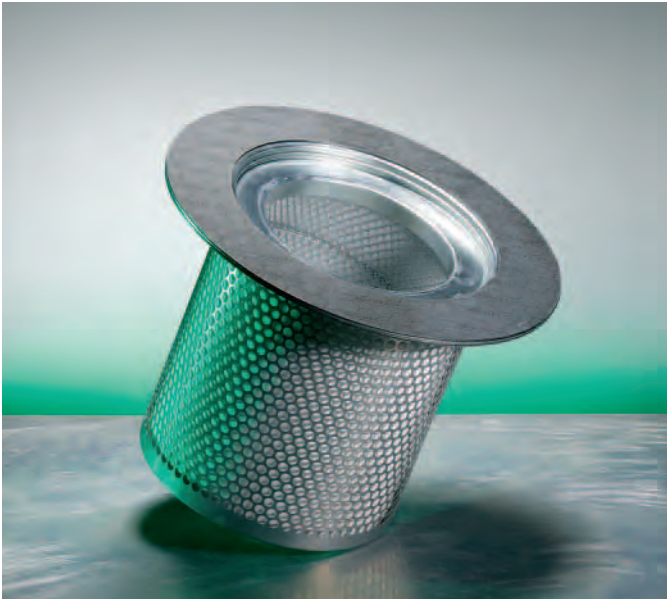

Fitting advice

Depth Separator Elements are available in a variety of sizes. They will only function properly when there is no leakage between the wet and the dry sides. Air should be guided in such a way as to prevent the air/oil stream impacting directly on the surface of the filter element.

Design and function

This product takes up very little space and is suitable for the entire range of current versions of screw-type and sliding vane compressors. In the depth separator element, oil flows from the outside to the inside.

Pressure drop

The pressure drop at nominal flow rate and at 7 bar (0.7 MPa) operating pressure with a new element is approx. 0.2 bar (20 KPa). If a higher resistance is permitted, the volumetric flow rate can be increased to 1.5 times the nominal flow rate without downgrading performance.

Pressure resistance

Depth separator elements are designed for pressure differences of at least 5 bar (0.5 MPa).



Separation efficiency

The residual oil content at nominal flow rate and at 7 bar (0.7 MPa) operating pressure is approx. 1 to 3 mg/m³.

Service life

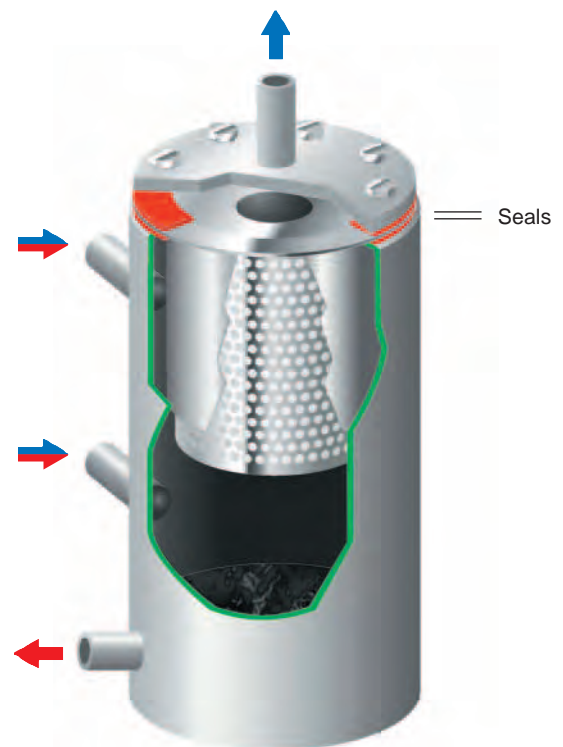
The rise in flow resistance and thus service life primarily depend on the cleanliness of the oil and the quality of the air filter. A service life of several thousand hours can be achieved with a well-functioning system.



-  Compressed air inlets for oil saturated air (2 inlet alternatives)
-  to oil injection
-  oil-free compressed air

Installation of Standard Wrap Element in pressure reservoir

Dimensions and order numbers

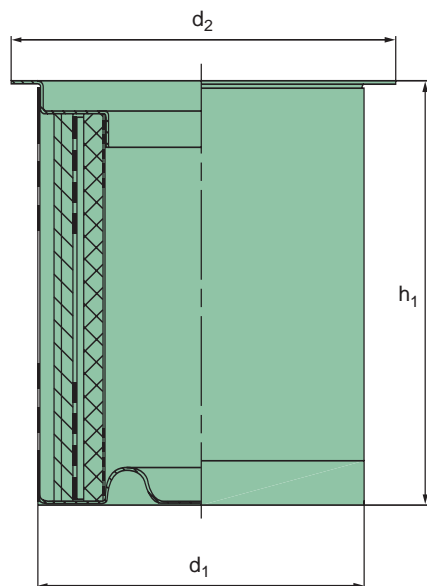

Order No.	Nominal flow rate ¹⁾ [m ³ /min] [cfm]	Dimensions in mm [<i>dimensions in inches</i>]			with seals
		d ₁	d ₂	h ₁	
49 401 53 102	1.3 [45.91]	135 [5.31]	160 [6.30]	65 [2.56]	–
49 300 55 171	1.8 [63.57]	110 [4.33]	165 [6.50]	100 [3.94]	x
49 300 53 222	2.2 [77.69]	100 [3.94]	175 [6.89]	150 [5.91]	–
49 301 53 401	3.3 [116.54]	135 [5.31]	170 [6.69]	160 [6.30]	–
49 301 53 141	3.7 [130.66]	135 [5.31]	220 [8.66]	175 [6.89]	–
49 301 53 131	4.3 [151.85]	135 [5.31]	170 [6.69]	200 [7.87]	–
49 301 55 151	4.3 [151.85]	135 [5.31]	215 [8.46]	200 [7.87]	x
49 301 53 532	5.2 [183.64]	170 [6.69]	220 [8.66]	160 [6.30]	–
49 301 55 361	5.2 [183.64]	110 [4.33]	165 [6.50]	250 [9.84]	x
49 403 53 121	5.3 [187.17]	170 [6.69]	200 [7.87]	180 [7.09]	–
49 404 53 111	5.7 [201.29]	220 [8.66]	274 [10.79]	160 [6.30]	–
49 301 53 151	5.8 [204.83]	220 [8.66]	274 [10.79]	160 [6.30]	–

¹⁾ Flow rate according to DIN 1945 at 7 bar (0.7 MPa) operating pressure.
Specially adapted sizes are available on request.

Dimensions and order numbers

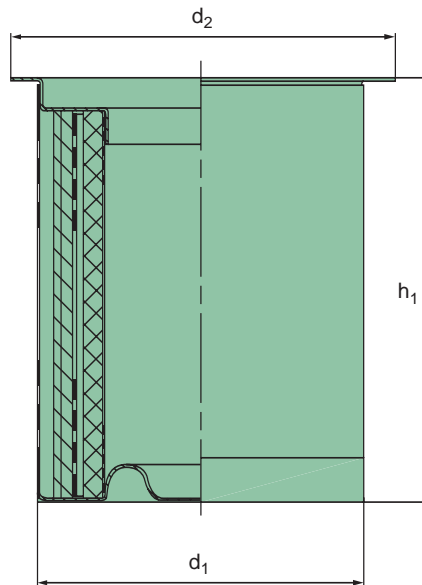

Order No.	Nominal flow rate ¹⁾ [m ³ /min] [cfm]	Dimensions in mm [<i>dimensions in inches</i>]			with seals
		d ₁	d ₂	h ₁	
49 301 53 101	6.5 [229.55]	170 [6.69]	200 [7.87]	230 [9.06]	–
49 302 55 151	6.8 [240.14]	135 [5.31]	178 [7.01]	305 [12.01]	x
49 406 55 101	8.6 [303.71]	220 [8.66]	274 [10.79]	230 [9.06]	x
49 302 53 131	8.9 [314.30]	170 [6.69]	200 [7.87]	305 [12.01]	–
49 302 55 581	8.9 [314.30]	275 [10.83]	296 [11.65]	190 [7.48]	x
49 302 53 451	9.0 [317.83]	220 [8.66]	274 [10.79]	240 [9.45]	–
49 406 55 111	9.5 [335.49]	220 [8.66]	328 [12.91]	250 [9.84]	x
49 407 53 101	11.0 [388.46]	275 [10.83]	328 [12.91]	230 [9.06]	–
49 302 53 321	11.2 [395.52]	170 [6.69]	200 [7.87]	380 [14.96]	–
49 302 55 131	11.8 [416.71]	220 [8.66]	290 [11.42]	305 [12.01]	x
49 408 53 101	12.1 [427.31]	275 [10.83]	328 [12.91]	250 [9.84]	–
49 302 53 171	12.5 [441.43]	170 [6.69]	245 [9.65]	420 [16.54]	–

1) Flow rate according to DIN 1945 at 7 bar (0.7 MPa) operating pressure.
Specially adapted sizes are available on request.

Dimensions and order numbers

Order No.	Nominal flow rate ¹⁾ [m ³ /min] [cfm]	Dimensions in mm [<i>dimensions in inches</i>]			with seals
		d ₁	d ₂	h ₁	
49 302 55 491	14.6 [515.59]	275 [10.83]	296 [11.65]	250 [9.84]	x
49 303 55 171	15.0 [529.72]	275 [10.83]	328 [12.91]	305 [12.01]	x
49 303 55 351	15.0 [529.72]	275 [10.83]	260 [14.17]	305 [12.01]	x
49 303 55 121	15.7 [554.44]	220 [8.66]	290 [11.42]	400 [15.75]	x
49 409 53 101	15.7 [554.44]	220 [8.66]	362 [14.25]	400 [15.75]	–
49 303 53 121	16.4 [579.16]	300 [11.81]	355 [13.98]	305 [12.01]	–
49 412 53 111	17.3 [610.94]	275 [10.83]	328 [12.91]	350 [13.78]	–
49 303 53 261	19.0 [670.98]	300 [11.81]	355 [13.98]	350 [13.78]	–
49 412 55 101	19.6 [692.17]	300 [11.81]	355 [13.98]	360 [14.17]	x
49 303 53 111	20.0 [706.29]	275 [10.83]	328 [12.91]	400 [15.75]	–
49 304 53 101	22.0 [776.92]	300 [11.81]	355 [13.98]	400 [15.75]	–
49 304 55 241	25.3 [893.46]	275 [10.83]	360 [14.17]	500 [19.69]	x
49 414 53 111	25.3 [893.46]	275 [10.83]	328 [12.91]	500 [19.69]	–
49 305 53 111	27.7 [978.22]	300 [11.81]	355 [13.98]	500 [19.69]	–
49 305 55 121	30.0 [1059.44]	300 [11.81]	355 [13.98]	540 [21.26]	x
49 418 53 111	33.5 [1183.04]	300 [11.81]	355 [13.98]	600 [23.62]	–
49 305 55 181	34.0 [1200.70]	350 [13.78]	430 [16.93]	440 [17.32]	x
49 306 55 131	38.6 [1363.15]	400 [15.75]	434 [17.09]	520 [20.47]	x
49 306 53 102	39.3 [1387.87]	300 [11.81]	355 [13.98]	700 [27.56]	–
49 306 53 181	43.0 [1518.53]	350 [13.78]	430 [16.93]	550 [21.65]	–
49 307 53 102	45.1 [1592.69]	300 [11.81]	355 [13.98]	800 [31.50]	–
49 307 55 111	46.4 [1638.60]	400 [15.75]	434 [17.09]	620 [24.41]	x

1) Flow rate according to DIN 1945 at 7 bar (0.7 MPa) operating pressure.
Specially adapted sizes are available on request.

MANN+HUMMEL



MANN+HUMMEL Air/oil separator boxes

MANN+HUMMEL Air/oil separator boxes

Flow rates

Air/oil separator boxes are available for nominal flow rates of 1 m³/min up to 5.5 m³/min at an operating pressure of 7 bar (0.7 MPa).

Pressure drop

The pressure drop at nominal flow rate and at 7 bar (0.7 MPa) operating pressure is approx. 0.25 bar (25 KPa) with a new element.



Pressure resistance

The housings of the air/oil separator boxes are designed for operating pressures up to a maximum of 20 bar (2 MPa) or a maximum of 14 bar (1.4 MPa). The fitted filter elements are suitable for pressure differences greater than 5 bar (0.5 MPa).

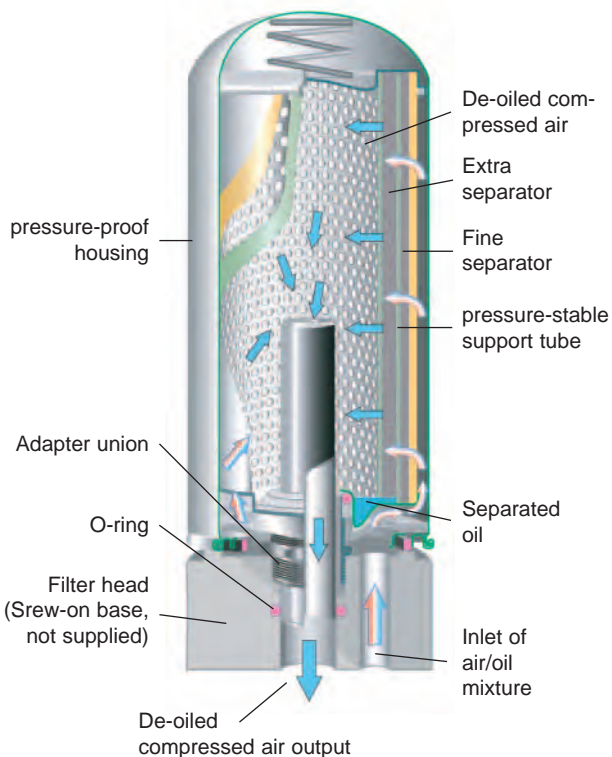

Fig. 1

Separation efficiency

The residual oil content of the compressed air at nominal flow rate and 7 bar (0.7 MPa) operating pressure is approximately 1 to 3 mg/m³.

Service life

The rise in flow resistance and thus service life primarily depend on the cleanness of the oil and the quality of the air filter. A service life of several thousand hours can be achieved with a well-functioning system.

Fitting advice

Air/oil separator boxes are fitted vertically (Fig. 1) by hand on the firmly installed filter head using a suitable adapter union. We recommend fitting in a position with good access for servicing.

Maintenance

The air/oil separator boxes must be replaced if the flow resistance reaches 1 bar (0.1 MPa). The box may only be replaced when the system is depressurised. A commercially available belt wrench is sufficient to remove the box. The box is fitted and tightened manually.

Dimensions and order numbers

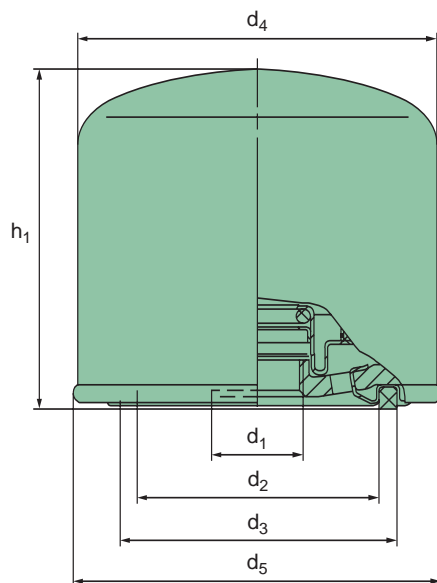

MANN-FILTER	Nominal flow rate ¹⁾ [m ³ /min] [cfm]	Dimensions in mm [<i>dimensions in inches</i>]						max. working pressure	
		d ₁	d ₂	d ₃	d ₄	d ₅	h ₁	[bar]	[MPa]
LB 719/2	1.0 [35.31]	M 22x1.5	62 [2.44]	71 [2.80]	76 [2.99]	80 [3.15]	127 [5.00]	20	2.0
LB 962/2	2.0 [70.63]	M 24x1.5	62 [2.44]	71 [2.80]	93 [3.66]	96 [3.78]	212 [8.35]	20	2.0
LB 1374/2	3.0 [105.94]	M 39x1.5	100 [3.94]	111 [4.37]	136 [5.35]	140 [5.51]	177 [6.97]	20	2.0
LB 11 102/2	4.0 [141.26]	M 32x1.5	93 [3.66]	104 [4.09]	108 [4.25]	110 [4.33]	260 [10.24]	14	1.4
LB 13 145/3	5.5 [194.23]	M 39x1.5	100 [3.94]	111 [4.37]	136 [5.35]	140 [5.51]	302 [11.89]	20	2.0

1) Flow rate according to DIN 1945 at 7 bar (0.7 MPa) operating pressure.

MANN+HUMMEL StarBox

High quality air/oil separators are crucial for process reliability and energy efficiency in compressors. The StarBox from MANN+HUMMEL sets new standards for both criteria in the separation of oil from compressed air. The new generation with more performance in the same installation space offers greater energy efficiency and process reliability. This has been made possible through a new high performance medium specially developed for compressors. As a result the StarBox, in comparison to conventional air/oil separator

boxes, performs better in the critical areas of residual oil content and differential pressure.

Advantages at a glance:

- up to 99 Euro energy saving per filter through lower differential pressure
- residual oil content of 1-3 ppm
- up to 25% longer service life in comparison to conventional air/oil separator boxes
- longer service life of the fine filters installed downstream

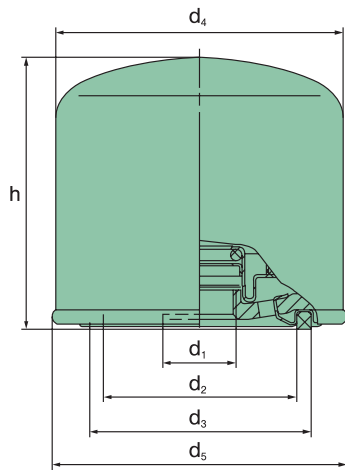

Energy saving per filter *

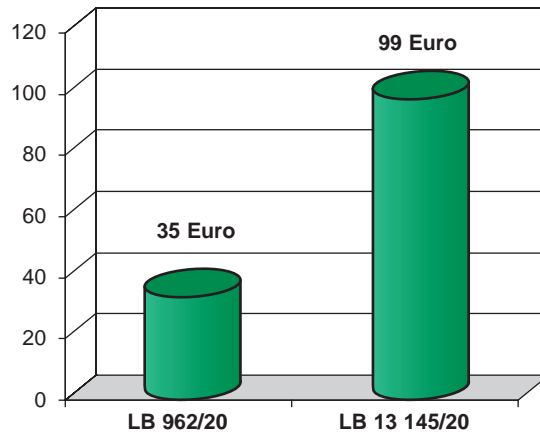

* Calculation based on a filter service life of 3,000 operating hours and power costs of 0.12 Euro per kWh, in comparison with a conventional air/oil separator box.

MANN-FILTER	Compatible to	Nominal flow rate [m ³ /min] [cfm]	Dimensions in mm [<i>dimensions in inches</i>]						max. working pressure	
			d ₁	d ₂	d ₃	d ₄	d ₅	h	[bar]	[MPa]
LB 962/20	LB 962/2	2.2 [77.69]	M 24x1.5	62 [2.44]	71 [2.80]	93 [3.66]	96 [3.78]	212 [8.35]	20	2.0
LB 13 145/20	LB 13 145/3	6.0 [211.89]	M 39x1.5	100 [3.94]	111 [4.37]	136 [5.35]	140 [5.51]	302 [11.89]	20	2.0



MANN+HUMMEL Air/oil separator filters

MANN+HUMMEL Air/oil separator filters



Fitting advice

The air/oil separator filters are fitted in an easily accessible position either vertical or suspended in the pipe downstream of the compressed air tank. Please observe the marked flow direction. The oil return pipe (steel pipe 8x1C-PHR) is fitted by the customer using the screw connection in the head. The steel pipe is not part of the scope of supply.

Maintenance

The air/oil separator boxes of the filters must be replaced if flow resistance reaches 1 bar (0.1 MPa). The box may only be replaced when the system is depressurised. A commercially available belt wrench is sufficient to remove the box. The box is fitted and tightened manually.

Flow rates

Air/oil separator filters are available for nominal flow rates of 1 m³/min up to 11 m³/min at a compressor pressure of 7 bar (0.7 MPa).

Separation efficiency

The residual oil content of the compressed air at nominal flow rate and at 7 bar (0.7 MPa) operating pressure is approx. 1 to 3 mg/m³.

Pressure drop

The pressure drop at nominal flow rate and at 7 bar (0.7 MPa) operating pressure is approx. 0.3 bar (30 KPa) with a new element.

Service life

The rise in flow resistance and thus service life primarily depend on the cleanliness of the oil and the quality of the air filter. A service life of several thousand hours can be achieved with a well-functioning system.

Pressure resistance

The housings of the air/oil separator filters are designed for operating pressures up to a maximum of 20 bar (2 MPa) or a maximum of 14 bar (1.4 MPa) (please refer to values in the table on page 15). The built-in filter elements can withstand pressure differences of an upwards 5 bar (0.5 MPa).

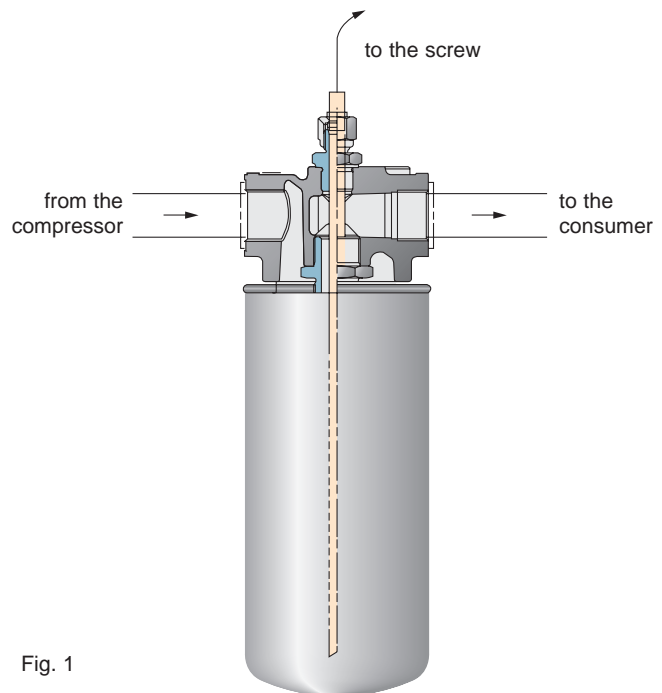

Fig. 1

Installation of the air/oil separator in the compressed air pipe

Dimensions and order numbers

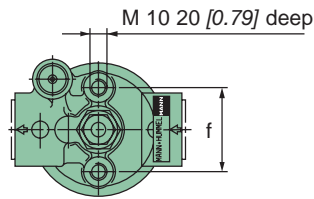
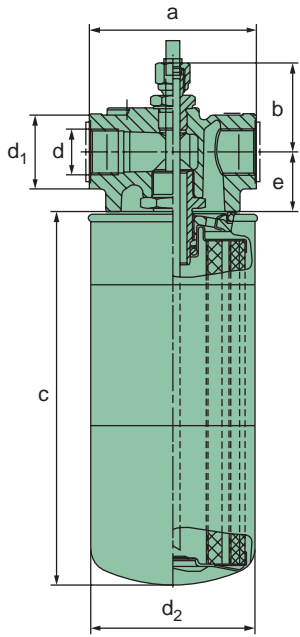

Fig. 1

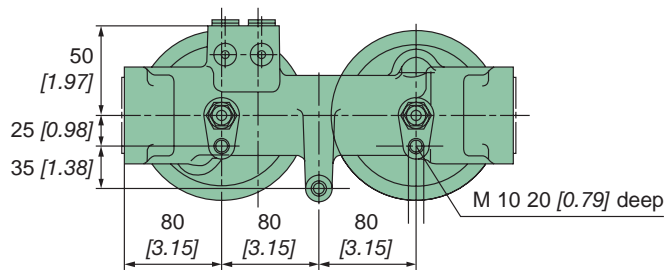
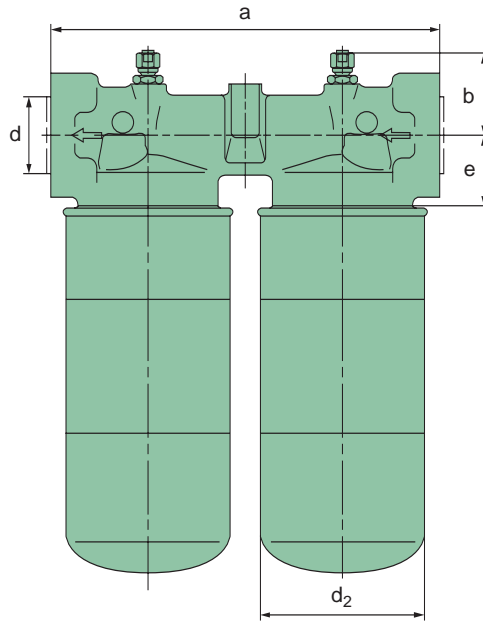
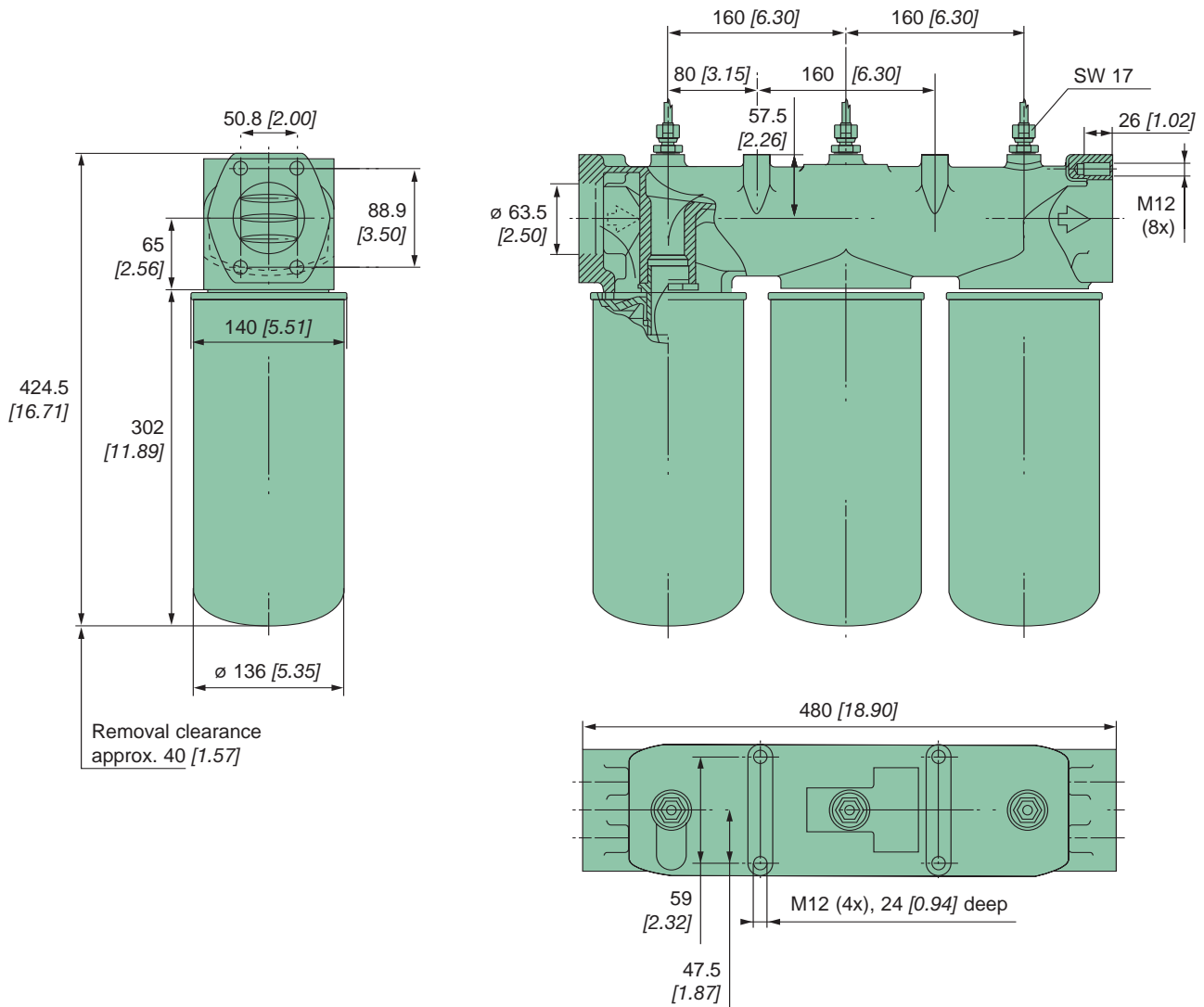

Fig. 2

Order No.	Mounted air/oil separator box	Fig.	Nominal flow rate ¹⁾ [m ³ /min] [cfm]	Dimensions in mm [<i>dimensions in inches</i>]								max. working pressure	
				a	b	c	d	d ₁	d ₂	e	f	[bar]	[MPa]
49 303 62 101	1x LB 719/2	1	1.0 [35.31]	95 [3.74]	50 [1.97]	127 [5.00]	G 3/4"	36 [1.42]	76 [2.99]	34 [1.34]	47.5 [1.87]	20	2.0
49 306 62 101	1x LB 962/2	1	2.0 [70.63]	95 [3.74]	50 [1.97]	212 [8.35]	G 3/4"	36 [1.42]	93 [3.66]	34 [1.34]	47.5 [1.87]	20	2.0
49 308 62 101	1x LB 1374/2	1	3.0 [105.94]	135 [5.32]	54 [2.13]	177 [6.97]	G 1 1/4"	50 [1.97]	136 [5.35]	41 [1.61]	56 [2.20]	20	2.0
49 316 62 101	1x LB 13 145/3	1	5.5 [194.23]	135 [5.32]	54 [2.13]	302 [11.89]	G 1 1/4"	50 [1.97]	136 [5.35]	41 [1.61]	56 [2.20]	20	2.0
49 330 62 101	2x LB 13 145/3	2	11 [388.46]	320 [12.60]	68 [2.68]	302 [11.89]	G 2"	-	136 [5.35]	58 [2.28]	-	20	2.0

1) Flow rate according to DIN 1945 at 7 bar (0.7 MPa) operating pressure.

Dimensions and order numbers



Order No.	Mounted air/oil separator box	Nominal flow rate ¹⁾ [m ³ /min] [cfm]	max. working pressure [bar] [MPa]
49 316 62 141	3x LB 13 145/3	16.5 [582.69]	20 2.0

1) Flow rate according to DIN 1945 at 7 bar (0.7 MPa) operating pressure.



MANN+HUMMEL Air/oil separators for vacuum pumps

MANN+HUMMEL Air/oil separators for vacuum pumps



Service life

The rise in flow resistance and thus service life primarily depend on the cleanness of the oil and the quality of the air filter. A service life of several thousand hours can be achieved with a well-functioning system.

Fitting advice

The full separation efficiency of the air/oil separators is only available fully when there is no leakage between the wet and dry sides.

Design and function

This model is designed for flows from the inside to the outside. The listed available air/oil separators are particularly suitable for integrated fitting in oil flooded vane vacuum pumps. The installation position can be chosen freely.

Pressure resistance

The air/oil separators for vacuum pumps are designed for differential pressures of up to at least 1.5 bar (150 KPa).

Separation efficiency

The residual oil content at nominal air flow is approx. 1 to 3 mg/m³.



Dimensions and order numbers

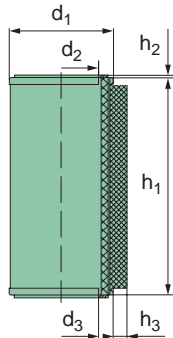

Fig. 1

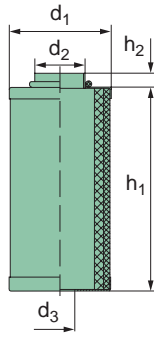

Fig. 2

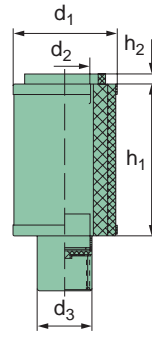

Fig. 4

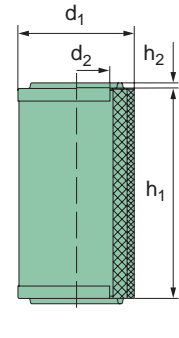

Fig. 6

Order No.	Fig.	Nominal flow rate [m ³ /min] [cfm]	Dimensions in mm [<i>dimensions in inches</i>]						with seals
			d ₁	d ₂	d ₃	h ₁	h ₂	h ₃	
49 000 53 108	1	0.1 [3.53]	30 [1.18]	10 [0.39]	10 [0.39]	60 [2.36]	-	-	-
49 000 52 114	2	0.1 [3.53]	35 [1.38]	G 3/8"	-	55 [2.17]	11 [0.43]	-	-
49 000 52 102	2	0.15 [5.30]	35 [1.38]	G 3/8"	-	55 [2.17]	11 [0.43]	-	-
49 000 51 401	4	0.15 [5.30]	55 [2.17]	26.5 [1.04]	29 [1.14]	40 [1.57]	5 [0.20]	-	x
49 000 52 115	2	0.2 [7.06]	35 [1.38]	G 3/8"	-	75 [2.95]	11 [0.43]	-	-
49 000 52 171	2	0.2 [7.06]	35 [1.38]	G 3/8"	-	85 [3.35]	11 [0.43]	-	-
49 000 52 109	2	0.25 [8.83]	35 [1.38]	G 3/8"	-	110 [4.33]	11 [0.43]	-	-
49 000 52 241	1	0.3 [10.59]	40 [1.57]	20.2 [0.80]	20.2 [0.80]	96 [3.78]	-	-	-
49 000 54 121	4	0.3 [10.59]	55 [2.17]	26.5 [1.04]	29 [1.14]	80 [3.15]	5 [0.20]	-	x
49 000 52 351	6	0.3 [10.59]	55 [2.17]	25.2 [0.99]	-	75 [2.95]	3 [0.12]	-	-

Customized versions are available on request.

Dimensions and order numbers

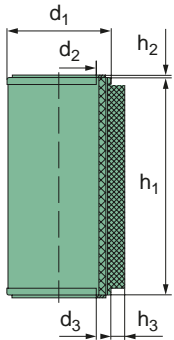

Fig. 1

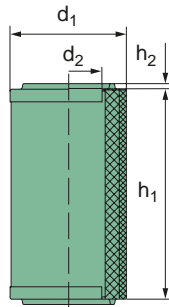

Fig. 6

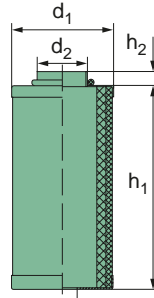

Fig. 2

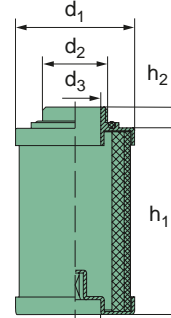

Fig. 7

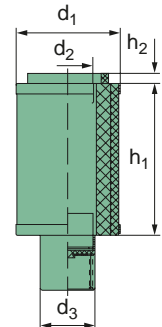

Fig. 4

Order No.	Fig.	Nominal flow rate [m ³ /min] [cfm]	Dimensions in mm [<i>dimensions in inches</i>]						with seals
			d ₁	d ₂	d ₃	h ₁	h ₂	h ₃	
49 000 54 361	7	0.3 [10.59]	55.5 [2.19]	M 25x2	15 [0.59]	77 [3.03]	13 [0.51]	-	x
49 000 54 211	4	0.3 [10.59]	56 [2.20]	26 [1.02]	29 [1.14]	80 [3.15]	5 [0.20]	-	x
49 000 52 501	2	0.4 [14.13]	53 [2.09]	28 [1.10]	-	120 [4.72]	9 [0.35]	-	-
49 000 50 391	4	0.4 [14.13]	55 [2.17]	26.5 [1.04]	29 [1.14]	95 [3.74]	5 [0.20]	-	x
49 000 52 352	6	0.4 [14.13]	72 [2.83]	32.2 [1.27]	-	80 [3.15]	2.5 [0.10]	-	-
49 000 53 106	1	0.5 [17.66]	55 [2.17]	25 [0.98]	25 [0.98]	135 [5.31]	-	-	-
49 000 52 271	6	0.5 [17.66]	55 [2.17]	25.2 [0.99]	-	130 [5.11]	3 [0.12]	-	-
49 000 55 251	1	0.5 [17.66]	65 [2.56]	43 [1.69]	43 [1.69]	100 [3.94]	3 [0.12]	-	x
49 000 54 351	7	0.5 [17.66]	72.5 [2.85]	M 32x2	22 [0.87]	83 [3.27]	13 [0.51]	-	x

Customized versions are available on request.

Dimensions and order numbers

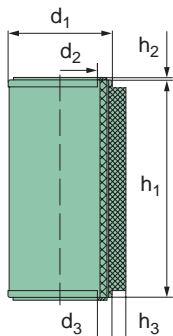

Fig. 1

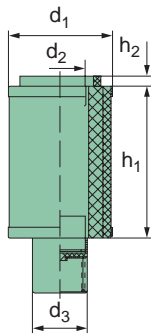

Fig. 4

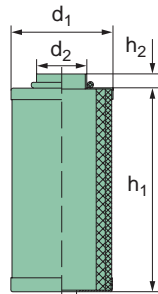

Fig. 2

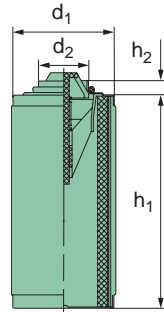

Fig. 5

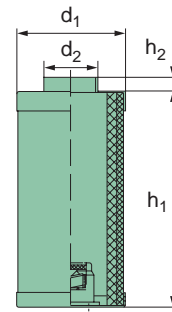

Fig. 3

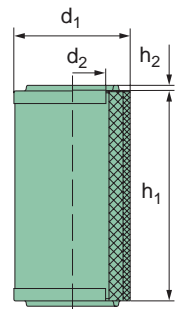

Fig. 6

Order No.	Fig.	Nominal flow rate [m ³ /min] [cfm]	Dimensions in mm [<i>dimensions in inches</i>]						with seals
			d ₁	d ₂	d ₃	h ₁	h ₂	h ₃	
49 000 54 201	4	0.6 [21.19]	56 [2.20]	26 [1.02]	29 [1.14]	177 [6.97]	5 [0.20]	-	x
49 000 54 151	1	0.6 [21.19]	65 [2.56]	43 [1.69]	43 [1.69]	100 [3.94]	3 [0.12]	-	x
49 000 54 191	4	0.6 [21.19]	84 [3.31]	51 [2.01]	35.5 [1.40]	100 [3.94]	5 [0.20]	-	x
49 000 54 131	4	0.7 [24.72]	55 [2.17]	26.5 [1.04]	29 [1.14]	177 [6.97]	5 [0.20]	-	x
49 000 52 105	3	0.7 [24.72]	72 [2.83]	35 [1.38]	-	125 [4.92]	9 [0.35]	-	-
49 000 52 353	6	0.7 [24.72]	80 [3.15]	45.2 [1.78]	-	125 [4.92]	3.5 [0.14]	-	-
49 000 54 111	4	0.7 [24.72]	82 [3.23]	52.5 [2.07]	35 [1.38]	100 [3.94]	5 [0.20]	-	x
49 000 52 181	2	0.8 [28.25]	53 [2.09]	28 [1.10]	-	202 [7.95]	9 [0.35]	-	-
49 000 55 241	5	0.8 [28.25]	72 [2.83]	35 [1.38]	3 [0.12]	130 [5.12]	10 [0.39]	-	x

Customized versions are available on request.

Dimensions and order numbers

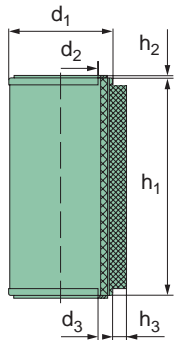

Fig. 1

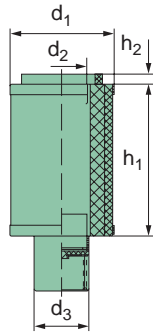

Fig. 4

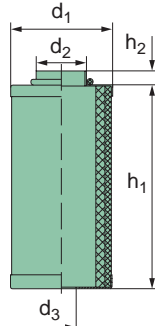

Fig. 2

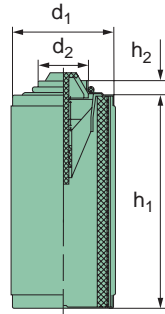

Fig. 5

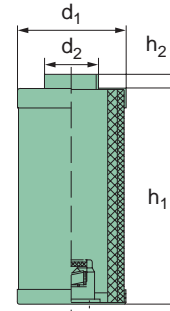

Fig. 3

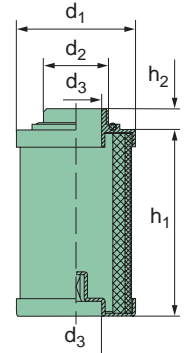

Fig. 7

Order No.	Fig.	Nominal flow rate [m ³ /min] [cfm]	Dimensions in mm [dimensions in inches]						with seals
			d ₁	d ₂	d ₃	h ₁	h ₂	h ₃	
49 000 55 301	7	0.8 [28.25]	82 [3.23]	M 45x3	35 [1.38]	128 [5.04]	14 [0.55]	-	x
49 000 50 611	1	0.9 [31.78]	80 [3.15]	45 [1.77]	45 [1.77]	145 [5.70]	-	-	-
49 000 50 612	1	0.9 [31.78]	80 [3.15]	45 [1.77]	45 [1.77]	145 [5.70]	-	-	-
49 000 54 261	1	1.2 [42.38]	71 [2.80]	41 [1.61]	8.4 [0.33]	227 [8.94]	2 [0.08]	-	x
49 000 55 221	5	1.25 [44.14]	72 [2.83]	35 [1.38]	3 [0.12]	208 [8.19]	10 [0.39]	-	x
49 000 54 102	2	1.3 [45.91]	82 [3.23]	50 [1.97]	9 [0.35]	200 [7.87]	10 [0.39]	-	x
49 000 51 451	4	1.3 [45.91]	82 [3.23]	52.5 [2.07]	35 [1.38]	200 [7.87]	5 [0.20]	-	x
49 000 53 107	1	1.4 [49.44]	70 [2.76]	41 [1.61]	41 [1.61]	250 [9.84]	-	-	-
49 000 52 103	2	1.45 [51.21]	72 [2.83]	35 [1.38]	-	252 [9.92]	9 [0.35]	-	-
49 000 50 571	3	1.45 [51.21]	72 [2.83]	35 [1.38]	-	252 [9.92]	9 [0.35]	-	-

Customized versions are available on request.

Dimensions and order numbers

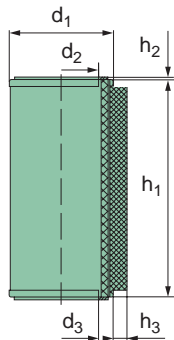

Fig. 1

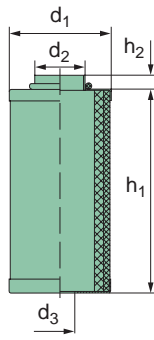

Fig. 2

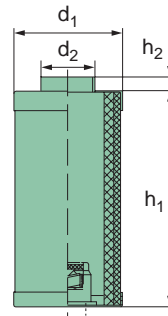

Fig. 3

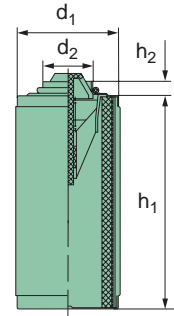

Fig. 5

Order No.	Fig.	Nominal flow rate [m ³ /min] [cfm]	Dimensions in mm [<i>dimensions in inches</i>]						with seals
			d ₁	d ₂	d ₃	h ₁	h ₂	h ₃	
49 000 52 201	2	1.5 [52.97]	72 [2.83]	35 [1.38]	–	252 [9.92]	9 [0.35]	–	–
49 000 55 341	2	1.5 [52.97]	72 [2.83]	35 [1.38]	3 [0.12]	250 [9.84]	9 [0.35]	–	x
49 000 55 231	5	1.5 [52.97]	72 [2.83]	35 [1.38]	3 [0.12]	250 [9.84]	10 [0.39]	–	x
49 001 53 112	1	1.8 [63.57]	70 [2.76]	41 [1.61]	41 [1.61]	330 [12.99]	–	–	–
49 000 50 461	1	2.0 [70.63]	108 [4.25]	73 [2.87]	73 [2.87]	220 [8.66]	6 [0.24]	12 [0.47]	x
49 001 52 108	1	2.2 [77.69]	108 [4.25]	75 [2.95]	75 [2.95]	230 [9.06]	–	–	–
49 001 52 171	2	2.2 [77.69]	72 [2.83]	35 [1.38]	–	377 [14.84]	9 [0.35]	–	–
49 000 50 651	3	2.2 [77.69]	72 [2.83]	35 [1.38]	–	377 [14.84]	9 [0.35]	–	–
49 001 55 171	2	2.3 [81.22]	72 [2.83]	35 [1.38]	3 [0.12]	375 [14.76]	10 [0.39]	–	x
49 001 55 201	5	2.3 [81.22]	72 [2.83]	35 [1.38]	3 [0.12]	375 [14.76]	10 [0.39]	–	x
49 001 54 100	1	2.5 [88.29]	108 [4.25]	73 [2.87]	73 [2.87]	285 [11.22]	6 [0.24]	12 [0.47]	x
49 001 52 110	2	2.5 [88.29]	82 [3.23]	50 [1.97]	9 [0.35]	380 [14.96]	10 [0.39]	–	x

Customized versions are available on request.

Dimensions and order numbers

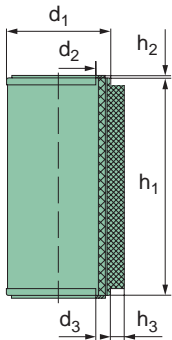

Fig. 1

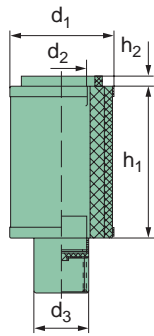

Fig. 4

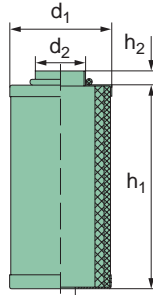

Fig. 2

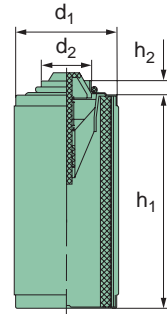

Fig. 5

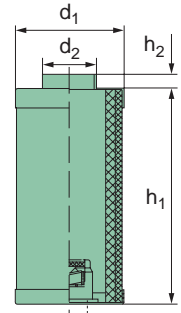

Fig. 3

Order No.	Fig.	Nominal flow rate [m ³ /min] [cfm]	Dimensions in mm [dimensions in inches]						with seals
			d ₁	d ₂	d ₃	h ₁	h ₂	h ₃	
49 000 51 341	4	2.65 [93.58]	82 [3.23]	52.5 [2.07]	35 [1.38]	400 [15.75]	5 [0.20]	-	x
49 001 54 281	1	2.70 [95.35]	71 [2.80]	41 [1.61]	8.4 [0.33]	398.5 [15.69]	2 [0.08]	25 [0.98]	x
49 001 52 151	2	2.90 [102.41]	72 [2.83]	35 [1.38]	-	502 [19.76]	9 [0.35]	-	-
49 001 52 172	2	2.90 [102.41]	72 [2.83]	35 [1.38]	-	502 [19.76]	9 [0.35]	-	-
49 000 50 661	3	2.90 [102.41]	72 [2.83]	35 [1.38]	-	502 [19.76]	9 [0.35]	-	-
49 001 54 105	2	2.90 [102.41]	82 [3.23]	50 [1.97]	9 [0.35]	450 [17.72]	10 [0.39]	-	x
49 001 55 181	2	3.10 [109.48]	72 [2.83]	35 [1.38]	3 [0.12]	500 [19.69]	10 [0.39]	-	x
49 001 55 191	5	3.10 [109.48]	72 [2.83]	35 [1.38]	3 [0.12]	500 [19.69]	10 [0.39]	-	x
49 002 52 171	2	3.60 [127.13]	82 [3.23]	50 [1.97]	9 [0.35]	540 [21.26]	10 [0.39]	-	x

Customized versions are available on request.



Accessories for MANN+HUMMEL Air/oil separators

Seals for MANN+HUMMEL Air/oil separators

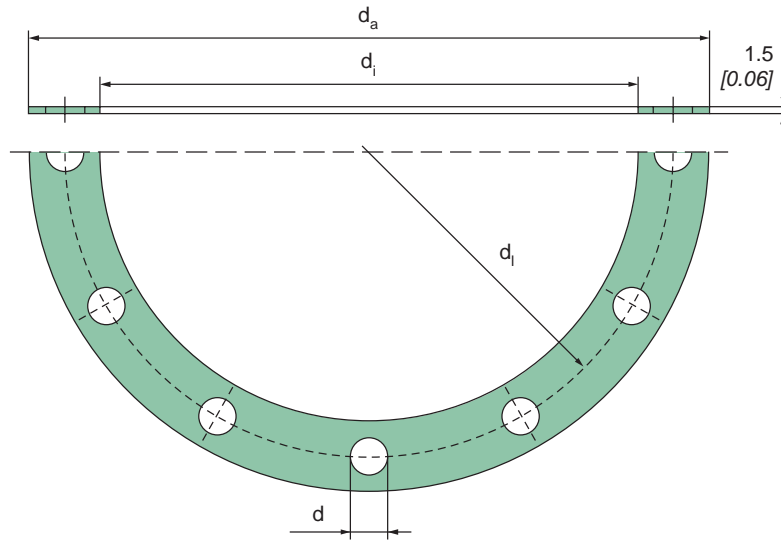

Order No.	Diameter Air/oil separator [mm] [inches]	d_a [mm] [inches]	d_i [mm] [inches]	d_i [mm] [inches]	d [mm] [inches] x Number of holes
23 074 31 212	73 [2.87]	111 [4.37]	73.5 [2.89]	—	—
23 113 31 141	110 [4.33]	154 [6.06]	113 [4.45]	—	—
23 114 31 991	110 [4.33]	165 [6.50]	113.5 [4.47]	—	—
23 128 31 101	125 [4.92]	165 [6.50]	128 [5.04]	—	—
23 134 31 101	135 [5.31]	155 [6.10]	135 [5.13]	—	—
23 138 31 134	135 [5.31]	178 [7.01]	138 [5.43]	—	—
23 138 31 981	135 [5.31]	165 [6.50]	138 [5.43]	—	—
23 138 31 141	135 [5.31]	215 [8.46]	138 [5.43]	—	—
23 138 31 971	135 [5.31]	215 [8.46]	138 [5.43]	—	—
23 138 31 961	135 [5.31]	178 [7.01]	138 [5.43]	—	—
23 138 31 171	135 [5.31]	190 [7.48]	138 [5.43]	—	—
23 172 31 123	170 [6.69]	238 [9.37]	172 [6.77]	—	—
23 172 31 124	170 [6.69]	195 [7.68]	172 [6.77]	—	—
23 172 31 131	170 [6.69]	245 [9.65]	172 [6.77]	210 [8.27]	17 [0.67] x 8
23 172 31 141	170 [6.69]	192 [7.56]	172 [6.77]	—	—

The listed seals have a thickness of 1.5 mm (0.06 inches).

Seals for MANN+HUMMEL Air/oil separators

Order No.	Diameter Air/oil separator [mm] [inches]	d _a [mm] [inches]	d _i [mm] [inches]	d _i [mm] [inches]	d [mm] [inches] x Number of holes
23 172 31 151	170 [6.69]	238 [9.37]	172 [6.77]	215 [8.46]	14 [0.55] x 8
23 172 31 951	170 [6.69]	200 [7.87]	172 [6.77]	–	–
23 172 31 171	170 [6.69]	220 [8.66]	172 [6.77]	–	–
23 172 31 941	170 [6.69]	245 [9.65]	172 [6.77]	210 [8.27]	13 [0.51] x 8
23 190 31 121	170 [6.69]	240 [9.45]	190 [7.48]	215 [8.46]	14 [0.55] x 12
23 203 31 101	200 [7.87]	240 [9.45]	203 [7.99]	–	–
23 223 31 105	220 [8.66]	238 [9.37]	223 [8.78]	–	–
23 223 31 106	220 [8.66]	290 [11.42]	223 [8.78]	–	–
23 223 31 131	220 [8.66]	284 [11.18]	223 [8.78]	–	–
23 223 31 107	220 [8.66]	274 [10.79]	223 [8.78]	–	–
23 223 31 111	220 [8.66]	265 [10.43]	223 [8.78]	–	–
23 223 31 121	220 [8.66]	250 [9.84]	223 [8.78]	–	–
23 230 31 121	170/220 [6.69/8.66]	295 [11.61]	230 [9.06]	265 [10.43]	13 [0.51] x 8
23 230 31 131	220 [8.66]	300 [11.81]	230 [9.06]	272 [10.71]	14 [0.55] x 12
23 278 31 103	275 [10.83]	296 [11.65]	278 [10.94]	–	–
23 278 31 104	275 [10.83]	328 [12.91]	278 [10.94]	–	–
23 278 31 111	275 [10.83]	375 [14.76]	278 [10.94]	–	–
23 278 31 991	275 [10.83]	296 [11.65]	278 [10.94]	–	–
23 300 31 101	300 [11.81]	348 [13.70]	300 [11.81]	–	–
23 303 31 112	300 [11.81]	355 [13.98]	303 [11.93]	–	–
23 303 31 122	300 [11.81]	440 [17.32]	303 [11.93]	–	–
23 303 31 131	300 [11.81]	343 [13.50]	303 [11.93]	–	–
23 303 31 981	300 [11.81]	440 [17.32]	303 [11.93]	–	–
23 303 31 151	300 [11.81]	400 [15.75]	303 [11.93]	350 [13.78]	26 [1.02] x 12
23 303 31 161	300 [11.81]	350 [13.78]	303 [11.93]	–	–

The listed seals have a thickness of 1.5 mm (0.06 inches).

Seals for MANN+HUMMEL Air/oil separators

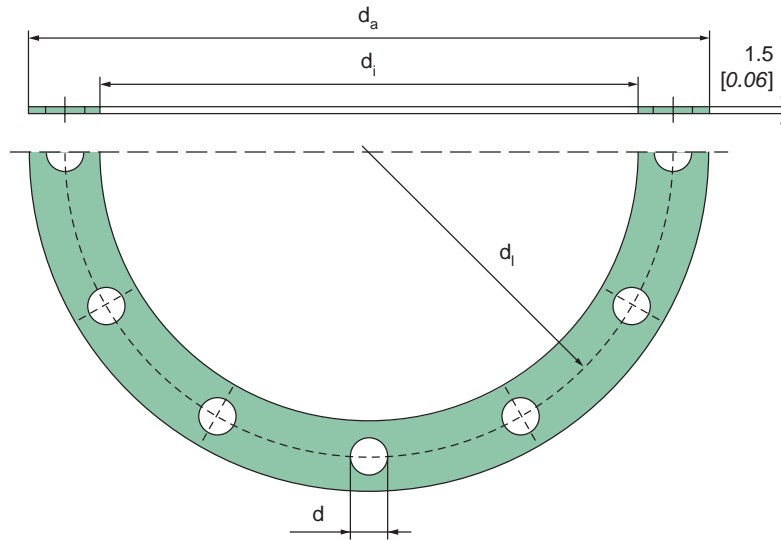

Order No.	Diameter Air/oil separator [mm] [inches]	d_a [mm] [inches]	d_i [mm] [inches]	d_i [mm] [inches]	d [mm] [inches] x Number of holes
23 303 31 171	300 [11.81]	390 [15.35]	303 [11.93]	—	—
23 303 31 191	300 [11.81]	328 [12.91]	303 [11.93]	—	—
23 320 31 131	300 [11.81]	360 [14.17]	320 [12.60]	—	—
23 353 31 101	350 [13.78]	430 [16.93]	353 [13.90]	—	—
23 353 31 981	350 [13.78]	430 [16.93]	353 [13.90]	—	—
23 353 31 121	350 [13.78]	395 [15.55]	353 [13.90]	—	—
23 403 31 101	400 [15.75]	434 [17.09]	403 [15.87]	—	—
23 403 31 121	400 [15.75]	500 [19.69]	403 [15.87]	460 [18.11]	18 [0.71] x 16
23 403 31 131	400 [15.75]	440 [17.32]	403 [15.87]	—	—
23 479 31 111	475 [18.70]	535 [21.06]	479 [18.86]	—	—
23 479 31 121	475 [18.70]	635 [25.00]	479 [18.86]	—	—
23 630 31 101	475 [18.70]	740 [29.13]	630 [24.80]	686 [27.01]	28 [1.10] x 24
23 600 31 102	595 [23.43]	700 [27.56]	600 [23.62]	660 [25.98]	23 [0.91] x 24

The listed seals have a thickness of 1.5 mm (0.06 inches).

Filter heads for MANN+HUMMEL Air/oil separators

These filter heads are available individually and are pressure-tested.

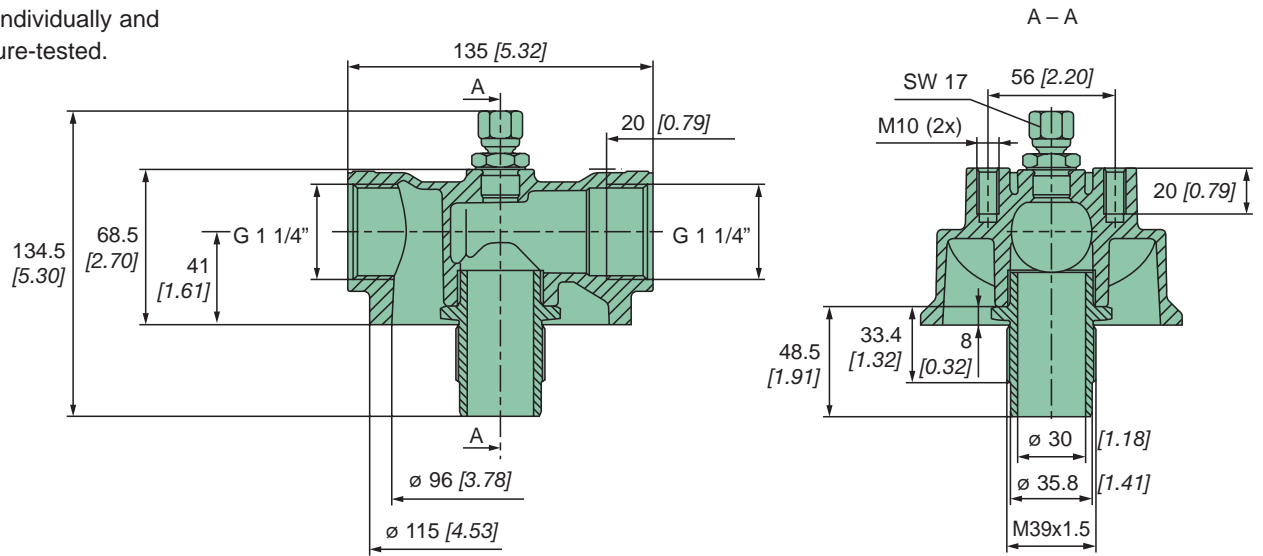

Fig. 1

Order No.	Fig.	Suitable air/oil separator box	max. working pressure	
			[bar]	[MPa]
67 700 31 801	1	1x LB 1374/2; 1x LB 13 145/3; 1x LB 13 145/20	20	2.0
67 730 31 861	2	2x LB 1374/2; 2x LB 13 145/3; 2x LB 13 145/20	20	2.0
67 750 31 971	3	3x LB 1374/2; 3x LB 13 145/3; 3x LB 13 145/20	20	2.0

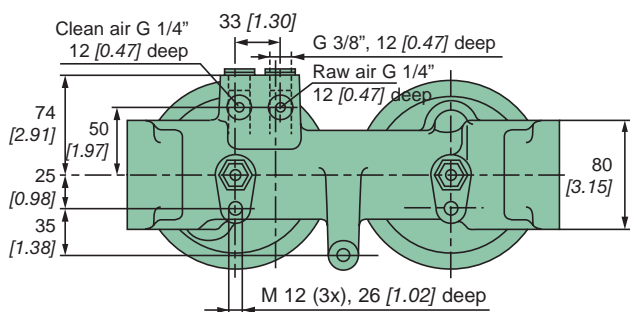
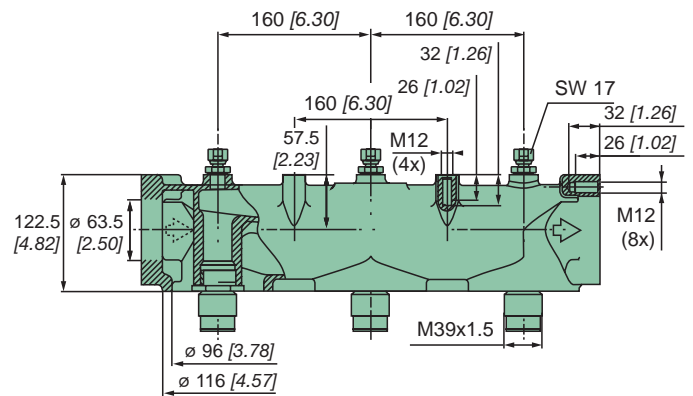
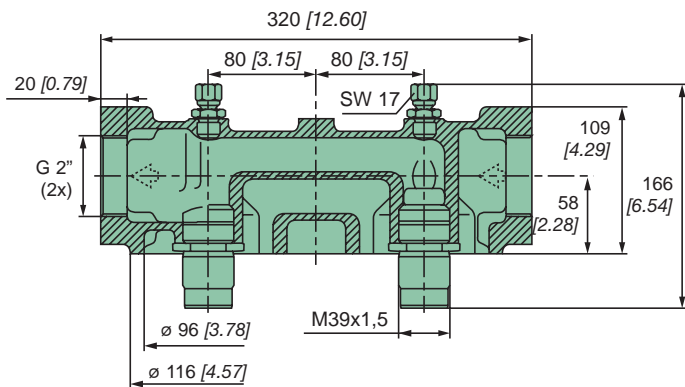

Fig. 2

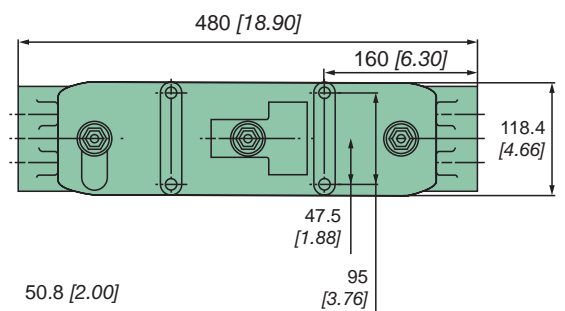
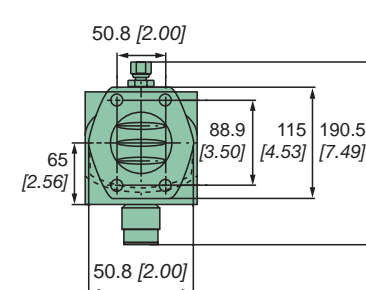
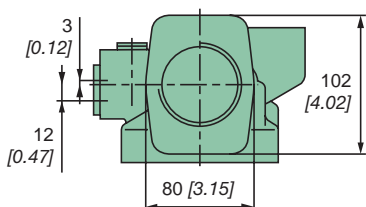
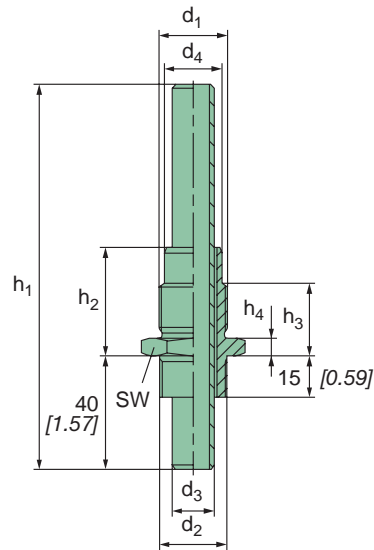

Fig. 3



Screw-on connectors for MANN+HUMMEL Air/oil separators



Order No.	Suitable air/oil separator box	Dimensions in mm [<i>dimensions in inches</i>]								
		d ₁	d ₂	d ₃	d ₄	h ₁	h ₂	h ₃	h ₄	SW
21 024 15 981	LB 719/2	M 22x1.5	M 24x1.5	14 [0.55]	19.2 [0.76]	135 [5.32]	38 [1.50]	25.4 [1.00]	6 [0.24]	27 [1.06]
21 027 15 991	LB 962/2	M 24x1.5	M 27x1.5	15 [0.59]	19.6 [0.78]	135 [5.32]	38 [1.50]	25.4 [1.00]	6 [0.24]	32 [1.26]
21 036 15 991	LB 11 102/2	M 32x1.5	M 36x1.5	22 [0.87]	28.1 [1.11]	155 [6.10]	41.5 [1.63]	27.4 [1.08]	6 [0.24]	41 [1.61]
21 042 15 991	LB 1374/2 LB 13 145/3	M 39x1.5	M 42x1.5	30 [1.18]	35.8 [1.41]	175 [6.89]	41.5 [1.63]	34.4 [1.35]	7 [0.28]	46 [1.81]

1) Flow rate according to DIN 1945 at 7 bar (0.7 MPa) operating pressure.



MANN+HUMMEL Oil Filters and Fuel Filters

MANN+HUMMEL Oil Filters: optimally designed



Compressor oil is a very expensive machine oil. High quality oil filters are recommended to conserve this oil and also to protect other parts of the compressed air system.

MANN+HUMMEL oil filters are particularly designed to handle the aggressive running conditions of the compressor.

Just as with air cleaners and air/oil separators, the oil filters in a compressed air system are also part of a process chain in which the weakest link can seriously lessen the performance of the whole system. If the oil filter does not work properly, the dirt deposits will negatively affect the air/oil separators, fine filters and machine components. The result is a considerable shortening of the filter service life and increased maintenance costs for the compressor.

Design

The spin-on filter consists of a robust metal housing with a filter element fitted inside. Depending on the application, the spin-on filter can be equipped with various components such as a different filter medium, a non-return valve, a bypass valve, etc.. The liquid to be filtered flows into the cover plate through concentric openings, flows through the filter element and finally the cleaned liquid exits through the central connection. An undetachable seal integrated in the cover plate ensures optimum sealing to the outside under all operating conditions.

Advantages at a glance:

- High dirt holding capacity
- Reliable function at cold start thanks to the bypass valve
- High mechanical stability of the whole filter and filter medium

Our MANN+HUMMEL filters are made with high performance filtration media and elastomers which are specially designed for use with compressors. They can withstand continuous high running temperatures with a safety reserve.

Further information is available in the MANN+HUMMEL catalogue for Liquid Filters (Order No. 19 942 10 101).

Types of spin-on filters

The dimension tables refer to these forms.

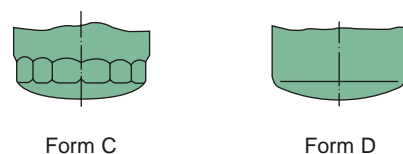
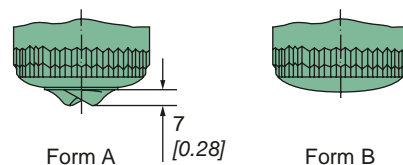

MANN+HUMMEL Oil Filters

Oil filters used with compressors have to be free of silicon to enable use of the compressors on paint-spray lines. Furthermore, compressors have different requirements for oil filters in comparison to engines. Firstly, the life of the oil and the oil filter is considerably longer in a compressor than in an engine. Secondly, the compressor oil and oil filter are not exposed to combustion residues and in addition are subjected to a lower temperature level.

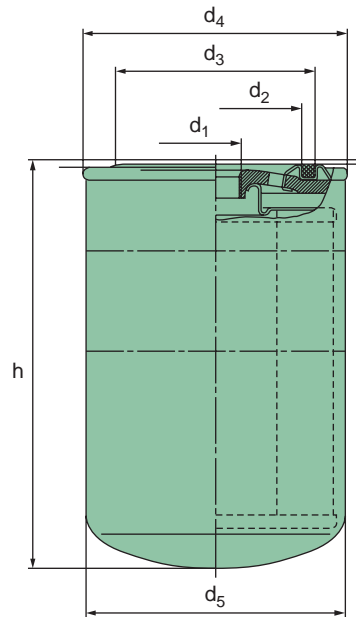

MANN-FILTER	Nominal flow rate [l/min] [gpm]	Dimensions in mm (<i>dimensions in inches</i>)						Filter fineness acc. to ISO 16 889 [µm (c)] * with 50% 99% separation efficiency		Non-return valve [bar]	By-pass valve [bar]	Permissible operating pressure		Type (see page 42)
		d ₁	d ₂	d ₃	d ₄	d ₅	h	[bar]	[MPa]					
W 712/65	20 [5.28]	3/4" - 16 UNF	62 [2.44]	71 [2.80]	80 [3.15]	76 [2.99]	93 [3.66]	20	> 50	0.12	2.5	14	1.4	C
W 719/37	30 [7.93]	3/4" - 16 UNF	62 [2.44]	71 [2.80]	80 [3.15]	76 [2.99]	123 [4.84]	20	> 50	0.12	2.5	14	1.4	C
W 920/51	30 [7.93]	3/4" - 16 UNF	62 [2.44]	71 [2.80]	96 [3.78]	93 [3.66]	95 [3.74]	20	> 50	0.12	2.5	14	1.4	A
W 920/40	35 [9.25]	3/4" - 16 UNF	62 [2.44]	71 [2.80]	96 [3.78]	93 [3.66]	95 [3.74]	14	38	0.12	1.2	14	1.4	B
W 930/35	40 [10.57]	3/4" - 16 UNF	62 [2.44]	71 [2.80]	96 [3.78]	93 [3.66]	114 [4.49]	20	> 50	0.12	2.5	14	1.4	A
W 940/55	55 [14.53]	3/4" - 16 UNF	62 [2.44]	71 [2.80]	96 [3.78]	93 [3.66]	142 [5.59]	20	> 50	0.12	2.5	14	1.4	A
W 950/24	70 [18.49]	1" - 12 UNF	62 [2.44]	71 [2.80]	96 [3.78]	93 [3.66]	170 [6.69]	14	38	0.12	1.6	14	1.4	B
W 962/14	75 [19.82]	1" - 12 UNF	62 [2.44]	71 [2.80]	96 [3.78]	108 [4.25]	210 [8.27]	14	38	–	2.5	14	1.4	B
W 962/18	100 [26.42]	1" - 12 UNF	62 [2.44]	71 [2.80]	96 [3.78]	108 [4.25]	210 [8.27]	5	19	0.12	2.5	14	1.4	B
W 1170	70 [18.49]	1" - 12 UNF	93 [3.66]	104 [4.09]	110 [4.33]	108 [4.25]	227 [8.94]	14	38	0.12	1.2	14	1.4	C
W 11 102	100 [26.42]	1 1/8" - 16 UN	93 [3.66]	104 [4.09]	110 [4.33]	108 [4.25]	260 [10.24]	20	> 50	0.12	2.5	14	1.4	C
WD 13 145/8	190 [50.20]	1 1/2" - 16 UN	100 [3.94]	111 [4.37]	140 [5.51]	136 [5.35]	302 [11.89]	15	38	–	2.5	20	2.0	D
WD 13 145/10	190 [50.20]	1 1/2" - 16 UN	100 [3.94]	111 [4.37]	140 [5.51]	136 [5.35]	302 [11.89]	< 3	7	–	2.5	20	2.0	D

* In comparison to the previously used calibration, the new calibration with the same filter results in a lower filter fineness with small particles.

Fine high performance – long-life oil filters

The oil filter is an important component for the reliable operation of a compressor. It prevents the unfiltered oil from entering the oil circuit. In particular, the oil filter protects the compressor screw against premature wear and extends the service life of the air/oil separator.

MANN+HUMMEL oil filters are designed to perform difficult operating conditions found in compressors. The

selected materials, e.g. metal, filter media and seals, are configured especially for this application and the aggressive oil in the system.

MANN+HUMMEL offers cellulose media for standard applications. Long-life oil filters with fibre-glass media are a better choice for the finest filter fineness of 10 µm absolute and a filter service life of several thousand operating hours.

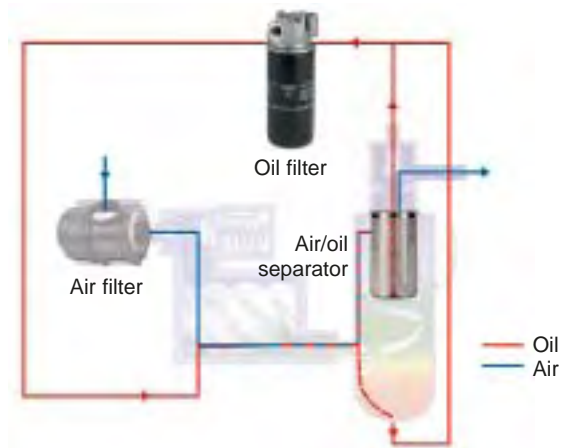
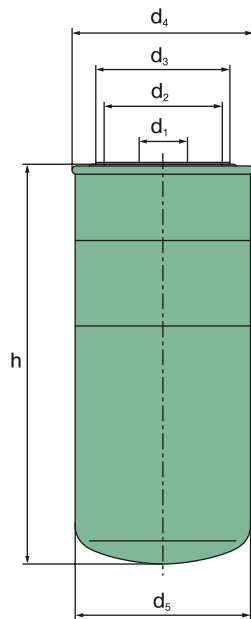

The finest filtration with MANN+HUMMEL long-life oil filters takes the load off the air/oil separators installed downstream and protects the screw.

MANN-FILTER	Nominal flow rate [l/min] [gpm]	Dimensions in mm (<i>dimensions in inches</i>)						Filter fineness acc. to ISO 16 889 [µm (c)] * with 50% 99% separation efficiency		Non- return valve [bar]	By- pass valve [bar]	Permissible operating pressure [bar] [MPa]		Type (see page 42)
		d ₁	d ₂	d ₃	d ₄	d ₅	h							
WD 962/21	65 [17.17]	1" - 12 UNF	62 [2.44]	71 [2.80]	96 [3.78]	93 [3.66]	212 [8.34]	4	10	–	2.5	25	2.5	D
WD 1374/6	110 [29.06]	1 1/2" - 16 UN	100 [3.94]	111 [4.37]	140 [5.51]	136 [5.35]	177 [6.97]	4	10	–	2.5	20	2.0	D
WD 13 145/14	210 [55.48]	1 1/2" - 16 UN	100 [3.94]	111 [4.37]	140 [5.51]	136 [5.35]	302 [11.89]	4	10	–	2.5	20	2.0	D

* In comparison to the previously used calibration, the new calibration with the same filter results in a lower filter fineness with small particles.

MANN+HUMMEL Fuel filters

MANN+HUMMEL spin-on filters are used for the filtration of fuel in a number of applications.

MANN+HUMMEL has been a leading manufacturer of spin-on filters worldwide for many years.

Advantages at a glance:

- Available with a range of filter media
- Efficient separation and high dirt holding capacity with low pressure drop



- Robust, anti-corrosion housing with high pulsation and pressure stability
- Geometry designed for optimum flow
- Undetachable seals
- Stable, non-collapsible central tube
- Non-return valve with low pressure drop

Further information is available in the MANN+HUMMEL catalogue for Liquid Filters (Order No. 19 942 10 101).

In-line fuel filters

PreLine® preliminary filter for the separation of water



Increasing pressures in injection systems have in turn considerably increased the requirements for fuel filtration with regard to the separation of water and particles. The injection pump manufacturers have therefore drawn up a list of requirements. MANN+HUMMEL filters more than completely fulfil the requirements.

Our PreLine® preliminary fuel filter series reliably meets the required water separation efficiency of at least 93% acc. to ISO 4020 thanks to the specially developed melt-blown medium.

The standard version has a manual pump and manual drain. Other versions are available with an electrical diesel heater and water sensor.

Advantages at a glance:

- Excellent water separation
- Design with highly integrated function
- High dynamic stiffness
- Optional: electrical heater in the inflow
- Increases the filter service life of the main filter
- Ideal as retrofit solution
- Protects modern injection systems against damage caused by corrosion and abrasion
- Reduces costs through longer engine life
- Reduces repair costs

Further information is available in the MANN+HUMMEL catalogue for Liquid Filters (Order No. 19 942 10 101).

MANN+HUMMEL



MANN+HUMMEL Air Cleaners

NLG: flexible – robust – economical

The new NLG line from MANN+HUMMEL offers a flexible and economic solution for many varied applications in the field of intake air filtration.

Advantages at a glance:

- High flexibility through variable modular system
- Economic air cleaner system through modular design
- Easy element change without tools
- Corrosion-free and robust housing through use of plastic reinforced with fibre-glass
- The Piclon version with integrated dust pre-separation can also be used with medium to heavy dust loads.

Further information is available in the MANN+HUMMEL catalogue for Air Cleaners (Order No. 19 941 10 101).

NLG Pico Single-stage air cleaner

Design	Single-stage plastic air cleaner
Volumetric flow range	10 m ³ /min to 50 m ³ /min
Operating temperature	Continuous: -40 °C to +80 °C for short periods: +100 °C
Main element	Star-pleated element with centre tube, radial seal, metal-free
Secondary element	Synthetic fabric element with centre tube, radial seal, metal-free
Selection criteria	Low pressure drop and highly economical with low dust loads
Typical applications	Trucks, mobile cranes, buses, stationary compressors, generators



NLG Piclon Two-stage air cleaners with integrated pre-separation

Design	Two-stage plastic air cleaner
Volumetric flow range	10 m ³ /min to 40 m ³ /min
Operating temperature	Continuous: -40 °C to +80 °C for short periods: +100 °C
Pre-separation	Vane to generate air spin
Main element	Star-pleated element with centre tube, radial seal, metal-free
Secondary element	Synthetic fabric element with centre tube, radial seal, metal-free
Selection criteria	Highly economical with medium dust loads
Typical applications	Mobile compressors, mobile cranes, construction site trucks, construction and agricultural machines



Europiclon® : the flexible allrounder

The Europiclon® from MANN+HUMMEL is characterised by its high dust capacity and low pressure drop.



These characteristics have made the Europiclon® the tried and tested air cleaner for all machines and equipment used in conditions with

medium to heavy dust loads. These include construction and agricultural machines, mobile compressors and harvesting machines.

Advantages at a glance:

- Long service life through integrated pre-separation
- Highly economical through modular system
- Extensive range of accessories
- Corrosion free housing in impact resistant plastic

- Easy element change without tools
- Highest operational reliability through elements with proven radial seal
- Metal-free filter elements are easily disposed of by incineration and therefore are environmentally friendly with inexpensive disposal
- Easy adaptation to other equipment with a flexible bracket system
- Patented filter elements

Design	Two-stage plastic air cleaner
Volumetric flow range	0.8 m³/min to 28 m³/min
Operating temperature	Continuous: -40 °C to +80 °C, for short periods: +100 °C
Pre-separation	Tangential inlet
Main element	Star-pleated element, centre tube in the housing, radial
Secondary element	Synthetic fabric element with centre tube, radial seal, metal-free
Selection criteria	Flexibility and economy with longer service life
Typical applications	Construction and agricultural machines, mobile compressors

Inline Piclon: Two-stage air cleaner with plastic housing

This two-stage air cleaner from MANN+HUMMEL with integrated pre-separation is available in three sizes. The Inline Piclon is particularly suited for use in medium dust conditions and for use with engines and compressors with pulsating intake air.

Advantages at a glance:

- Linear air flow
- Compact design
- Economical air cleaner system with integrated bracket
- Easy element change without tools
- Corrosion-free and robust housing through use of recyclable plastic
- Threaded inserts integrated in housing enable quick first-fit on vehicle



Design	Two-stage plastic air cleaner
Volumetric flow range	3 m³/min to 8 m³/min
Operating temperature	Continuous: -40 °C to +80 °C, for short periods: +100°C
Pre-separation	Vane to generate air spin
Main element	Star-pleated element with centre tube, axial seal, reinforced with metal
Secondary element	Synthetic fabric element with centre tube, axial seal, reinforced with metal
Selection criteria	Linear air flow when fitting to engine and medium dust loads
Typical applications	General mechanical engineering and vehicle construction

Piclon: Two-stage air cleaner with metal housing

The Piclon line from MANN+HUMMEL, with its proven two-stage air cleaners, has long been established in our range of air cleaners.

The air cleaners are particularly robust, have very good filtration characteristics and are excellently suited for use in very dusty conditions with high mechanical loads, e.g.

in construction and agricultural machines. But you will also find these filters at work in quarries, cement plants and mines. They are also used in applications which specify a flame-resistant housing.

Advantages at a glance:

- Especially robust metal design
- Long filter service life with low pressure drop
- Particularly robust filter elements with centre tubes in metal
- Different versions available for the dust discharge
- Secondary element available as optional extra



Design	Two-stage metal air cleaner
Volumetric flow range	2 m ³ /min to 60 m ³ /min
Operating temperature	Continuous: -40 °C to +100 °C, for short periods: +120 °C
Pre-separation	Vane to generate air spin
Main element	Star-pleated element with centre tube, axial seal, reinforced with metal
Secondary element	Synthetic fabric element with centre tube, axial seal, reinforced with metal
Selection criteria	Long service life with very high mechanical stress on the housing
Typical applications	Construction and agricultural machines, engine construction

Pico-E: single-stage air cleaner with metal housing

The Pico-E line from MANN+HUMMEL, with its proven single-stage air cleaners, has long been established in our range of air cleaners.

The air cleaners are particularly robust and are characterised by excellent filtration performance. They are very suitable for use in conditions

with low to medium dust loads and for applications with high mechanical loads such as with stationary engines, locomotives, fire-fighting vehicles, marine applications and other applications where a low pressure drop, particularly high mechanical stability, or a flame-resistant housing are required.

Advantages at a glance:

- Very robust metal design
- Long filter service life with low pressure drop
- Especially robust filter elements with centre tubes in metal
- Secondary element available as optional extra



Design	Single-stage metal air cleaner
Volumetric flow range	3 m ³ /min to 60 m ³ /min
Operating temperature	Continuous: -40 °C to +100 °C, for short periods: +120 °C
Main element	Star-pleated element with centre tube, axial seal, reinforced with metal
Secondary element	Synthetic fabric element with centre tube, axial seal, reinforced with metal
Selection criteria	Low pressure drop with very high mechanical stress on the housing
Typical applications	Compressors, generators

Picolino: compact air cleaner for high requirements

The Picolino line from MANN+HUMMEL offers exceptional filtration in a compact installation space with excellent flexibility. The Picolino line is available with a number of different connections to enable it to adapt to different applications.



Advantages at a glance:

- Excellent flexibility through variable modular system
- Economical air cleaner system through combination of standard parts
- Easy element change without tools
- Corrosion-free and robust housing through use of plastic reinforced with fibre-glass
- Temperature resistant to +130 °C (for short periods)
- Material with high temperature stability available for adapters on request
- Quick response to customised filtration solutions
- Metal-free filter elements are easily disposed of by incineration and therefore are environmentally friendly with inexpensive disposal
- Patented filter elements with radial seal

Design	Single-stage plastic air cleaner
Volumetric flow range	0.15 m ³ /min to 3.2 m ³ /min
Operating temperature	Continuous: -30 °C to +100 °C, for short periods: +120 °C
Filter element	Star-pleated element, radial seal, metal-free
Typical applications	Filters for two-way ventilation, small engines, small piston compressors, general mechanical engineering

Picolight: single-stage air cleaner without housing

The metal-free air cleaners of the Picolight line from MANN+HUMMEL are characterised by an especially low-weight and compact design. We particularly recommend these air cleaners for use in stationary applications with low dust loads such as generators, compressors, marine engines, etc.

Advantages at a glance:

- Low pressure drop
- Very economical
- Compact design
- Metal-free design
- Excellent filtration performance

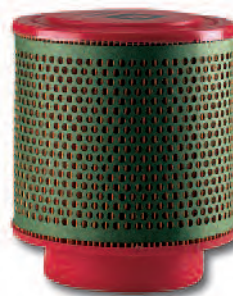

Design	Single-stage air cleaner without housing
Volumetric flow range	1 m ³ /min to 100 m ³ /min
Operating temperature	Continuous: -30 °C to +80 °C, for short periods: +100 °C
Filterelement	Star-pleated element, radial seal, metal-free
Typical applications	Stationary compressors, gen-erators, marine applications

Vacuum air cleaners

The airtight vacuum air cleaners from MANN+HUMMEL are designed for installation in air and gas pipes. They are airtight up to 1000 mbar negative pressure and equipped with a filter element. They are also used as intake filters in vacuum pumps.

Advantages at a glance:

- Reliable sealing
- Compact design
- Robust metal design
- Different connections are available
- Excellent filtration performance



Design

Volumetric flow range

Operating temperature

Filterelement

Typical applications

Single-stage metal air cleaner

0.7 m³/min to 12 m³/min

Continuous: -30 °C to +80 °C, for short periods: +100 °C

Star-pleated element with centre tube, axial seal, reinforced with metal

Air and gas pipes with negative pressure (vacuum pumps)



Further information is available in the MANN+HUMMEL catalogue for Air Cleaners (Order No. 19 941 10 101).



Technical Annex

General information on air/oil separation

Service life of air/oil separators

Dirt deposits, e.g. old oil products, air contamination or abrasion reduce the service life of air/oil separators.

Various final differential pressures are determined by the user. In practice, final values of between 0.8 bar (80 KPa) and 1 bar (100 KPa) are nor-

mal for compressors and approx. 0.5 bar (50 KPa) for vacuum pumps. Fouling which accumulates in the air/oil separator may also increase on account of higher oil flow. This is measurable as drainage flow. The drainage flow volume depends directly

on the structural design of the pre-separation mechanisms in the compressor. Optimum values for drainage flows are around 1 g of oil per m³ of oil.

Measures to secure an economic service life of air/oil separators

Correct oil care is a basic precondition for a satisfactory service life of air/oil separators. Generally speaking, the service life of air/oil separators is only restricted by deposits of solid particles (old oil products, abrasion) in the fine separation layer and the resulting increase in differential pressure. The entry of fouling into the lubricating oil can be restricted by changing the air and oil filters in good

time and by observing the oil change intervals. The amount of fouling entering the air/oil separator is thus kept to a minimum and this has a positive effect on maintenance intervals.

The selection of oil also plays an important role as regards service life. Only approved, aging-resistant and water-insensitive oils should be used. Unsuitable oils with insufficient oxidation resi-

stance may block the air/oil separator even after a relatively short operating period due to the build-up of deposits which have a similar consistency to jelly. Accelerated oil aging is the result of high operating temperatures.

Accordingly, attention must be paid to the supply of cooling air and to cooler contamination. During an oil change the old oil should be completely replaced in order to

avoid premature damage through residual oil or oil incompatibility when changing the type of oil. In order to take full advantage of the long service life of synthetic oils, any existing mineral oil residues must be removed completely.

In rare cases, oil may age prematurely due to gaseous foreign substances which are entrained in with the ambient air.

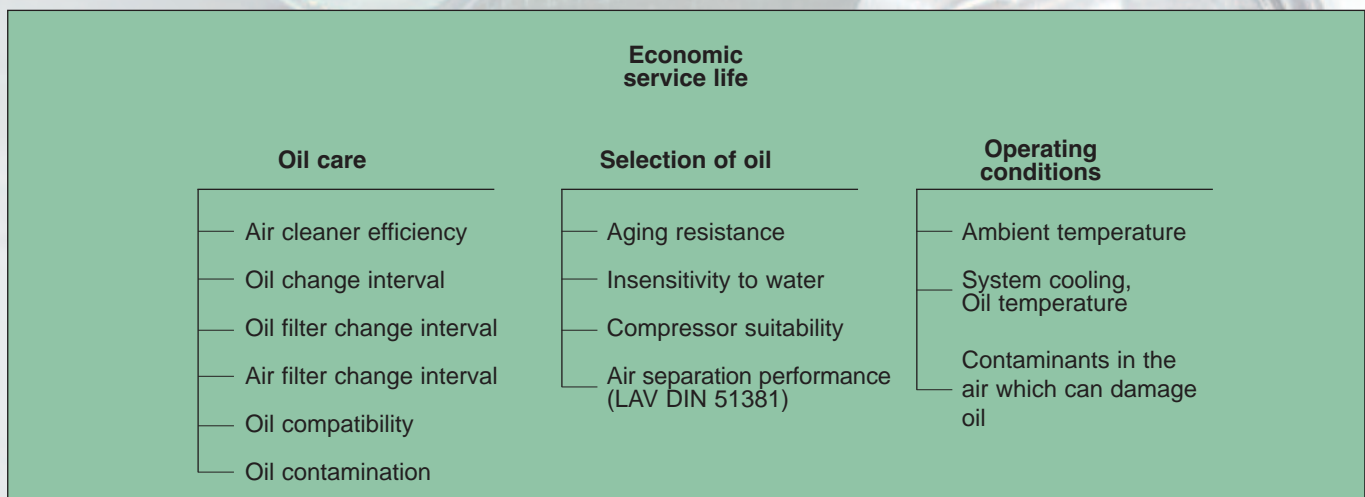

General information on air/oil separation

Reduced service life due to operational faults in compressors

Air/oil separators are insensitive to normal back flows or pulsation. However, abnormally large backflows may lead to defects in the fine separation layer of the air/oil separators. This damage is generally not visible and therefore cannot be detected

Improvements in pre-separation in existing compressors

In spite of the above reasons, the air/oil separators in compressors with imperfect pre-separation may still have an adequate service life if three-layer elements are used. The so-called third layer consists of an open-pore fleece in front of the fine separation layers and separates a considerable proportion of the large oil drops. In individual cases, this pre-separation layer can be retrofitted.

with the naked eye. However, even small defects in the separation layers may produce higher residual oil contents. In order to identify this damage, extensive tests such as residual oil measurements and destructive tests must be carried out.

Oil consumption in the compressor

Operating and marginal conditions which have an effect on the oil level in the pressure reservoir of the compressor, oil degasification processes, the effectiveness of pre-separation and the drainage system may result in increased oil flow rates in the short or long terms. For example, blockages in the drainage system lead to an accumulation of oil on the dry side of the air/oil separator. Depending on the accumulated quantity, different quantities of oil may be accumulated.

Residual oil measurements

Residual oil contents are measured most effectively using suitable absolute filters. In this case, it is important to measure both the oil drops and the wall flow since larger drops tend to be deposited on the wall. In order to avoid problems with condensation water, we recommend you

carry out measurements of residual oil when the system is without pressure. Measuring devices containing electronic particle counters only detect the air-borne proportion of oil drops and do not take any account of the wall flow.

An excessive oil level in the pressure reservoir may have similar effects. If a marked phase separation zone cannot be formed between the oil and air either temporarily or permanently, this will impair the pre-separation of the oil drops and also have a negative effect on the residual oil content downstream of the air/oil separator after a certain size. Overfilling the receiver tank with oil may lead to the penetration of abnormally large amounts of foaming oil into the air/oil separator under

certain operating conditions at low oil temperatures and when slowly degassing oils are used. The oil flow rate may rise substantially due to overwetting of the air/oil separator. In addition to the above-mentioned influences and operating faults which have a negative effect on oil consumption, the vaporous oil portion may reach a considerable level and thus also simulate faults in an air/oil separator. Depending on the type and make of oil, oil vapour contents of up to 10 mg/m³ are possible at normal operating temperatures of 80 °C.

Protection against corrosion

Air/oil separators are galvanised and thus protected against corrosion.

Increased oil consumption

- Blocked drainage line
- Wrong type of oil
- Oil vapour content too high
- Overfilled sump
- Air release
- Oil foam build-up

Fitting and servicing information

An air/oil separator or an air/oil separator box must be changed when it reaches the final differential pressure which is determined for each product and is dependent on economic considerations.

Air/oil separators and air/oil separator boxes are easy to handle and install, and pose no special problems.

However, the time taken to install or replace air/oil separators and air/oil separator boxes depends on the parti-

cular installation conditions and may increase in the case of larger systems with greater dimensions and component weights.

Whenever an air/oil separator is installed or replaced, care should be taken to ensure that the associated seals are in a perfect state and that they are seated properly. In normal cases, the seals are selected and supplied by the compressor manufacturer.

In the case of standard ele-

ments with flow from the outside to the inside and upright installation, special attention must be paid to the discharge of drainage oil. The scavenge pipe must have the correct length and extend as far as the base cup of the element.

It is very easy to replace the so-called air/oil separator boxes which are merely screwed on or off from the outside.



MANN+HUMMEL quality: from development up to series production

Filter requirements for compressed air systems are increasing all the time. We offer OEM quality for air/oil separators, air cleaners and oil filters and thus meet these requirements.

Decades of close cooperation and development partnerships with global leaders for OEM products have made us what we are today: experts for filtration applications in compressed air systems. We offer first class quality for both OEM and aftermarket products.

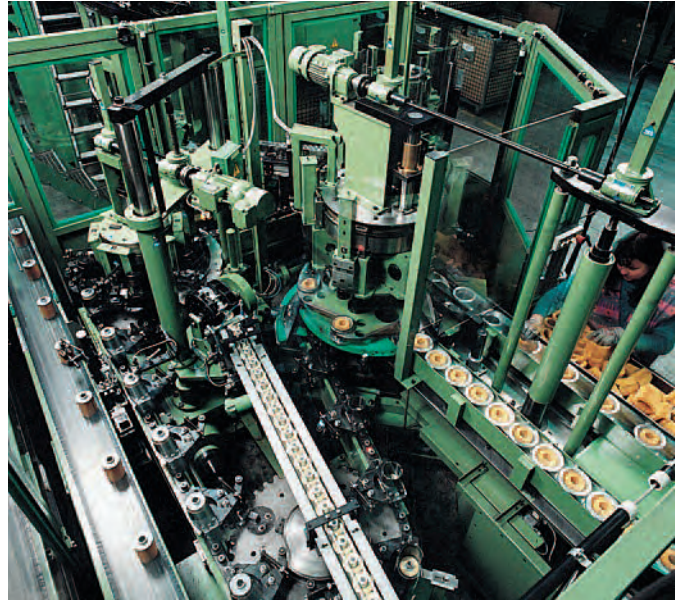

All filters – air/oil separators, air cleaners and oil filters – are specially designed in the development phase to work perfectly with the compressed air system in question. This ensures optimal interaction between the filter systems and efficient operation of the compressor.

Our expertise is also reflected in a number of development areas, e.g. our own media development or highly modern testing systems. New filters are tested there under extreme conditions which only seldom occur in the usual operation of the compressor.

In addition, we take great care to select our materials thoroughly. In co-operation with our suppliers we concentrate on working with partners which have their own quality assurance system. This guarantees us a consistently high quality for the end product.

With MANN+HUMMEL quality you are on the safe side!

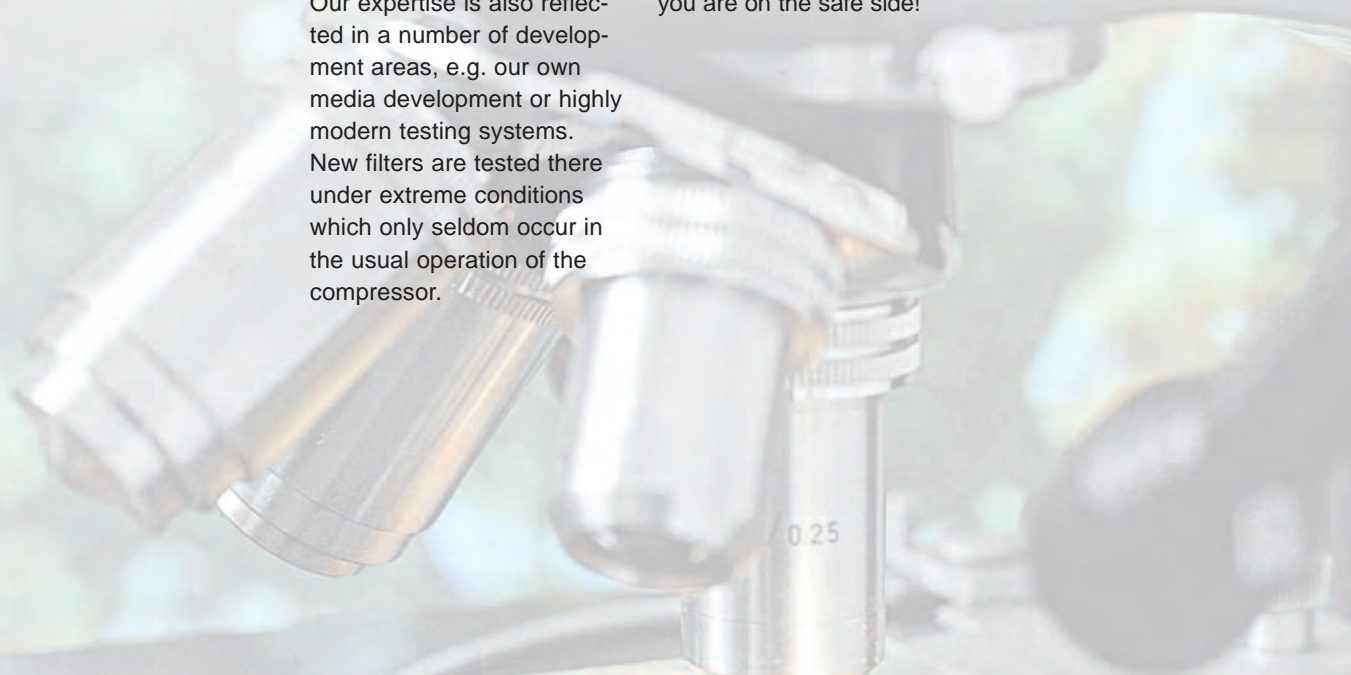

MANN FILTER

MANN-FILTER: the original is the best replacement



Inferior copies – high risk

Original products have always been copied by pirates and offered at lower prices. But a farsighted operator of a compressed air system will know that copies are products with an inferior quality which do not fit properly and force running costs up. Indeed they endanger the economic running of the compressed air system. In the worst case copies can lead to shutdown of the compressor.

Therefore you should be exactly aware of the small but critical differences between copies and the original products.

Only original filters from MANN+HUMMEL offer you all the advantages you expect from a high quality filter.

List of contents acc. to part numbers

Part no.	Name	Page	Part no.	Name	Page
21 024 15 981	Screw-on connector	40	49 000 50 461	Air/oil separator for vacuum pump	33
21 027 15 991	Screw-on connector	40	49 000 50 571	Air/oil separator for vacuum pump	32
21 036 15 991	Screw-on connector	40	49 000 50 611	Air/oil separator for vacuum pump	32
21 042 15 991	Screw-on connector	40	49 000 50 612	Air/oil separator for vacuum pump	32
23 074 31 212	Seal	36	49 000 50 651	Air/oil separator for vacuum pump	33
23 113 31 141	Seal	36	49 000 50 661	Air/oil separator for vacuum pump	34
23 114 31 991	Seal	36	49 000 51 101	Standard wrap element	13
23 128 31 101	Seal	36	49 000 51 111	Standard wrap element	12
23 134 31 101	Seal	36	49 000 51 121	Standard wrap element	12
23 138 31 134	Seal	36	49 000 51 131	Standard wrap element	13
23 138 31 141	Seal	36	49 000 51 171	Standard wrap element	13
23 138 31 171	Seal	36	49 000 51 181	Standard wrap element	13
23 138 31 961	Seal	36	49 000 51 191	Standard wrap element	13
23 138 31 971	Seal	36	49 000 51 201	Standard wrap element	11
23 138 31 981	Seal	36	49 000 51 221	Standard wrap element	13
23 17 231 941	Seal	37	49 000 51 231	Standard wrap element	12
23 172 31 123	Seal	36	49 000 51 241	Standard wrap element	12
23 172 31 124	Seal	36	49 000 51 251	Standard wrap element	13
23 172 31 131	Seal	36	49 000 51 311	Standard wrap element	11
23 172 31 141	Seal	36	49 000 51 321	Standard wrap element	13
23 172 31 151	Seal	37	49 000 51 331	Standard wrap element	13
23 172 31 171	Seal	37	49 000 51 341	Air/oil separator for vacuum pump	34
23 172 31 951	Seal	37	49 000 51 401	Air/oil separator for vacuum pump	29
23 19 031 121	Seal	37	49 000 51 411	Standard wrap element	12
23 203 31 101	Seal	37	49 000 51 441	Standard wrap element	13
23 223 31 105	Seal	37	49 000 51 451	Air/oil separator for vacuum pump	32
23 223 31 106	Seal	37	49 000 51 481	Standard wrap element	13
23 223 31 107	Seal	37	49 000 51 491	Standard wrap element	11
23 223 31 111	Seal	37	49 000 51 521	Standard wrap element	13
23 223 31 121	Seal	37	49 000 51 531	Standard wrap element	11
23 223 31 131	Seal	37	49 000 51 541	Standard wrap element	13
23 230 31 121	Seal	37	49 000 51 581	Standard wrap element	13
23 230 31 131	Seal	37	49 000 51 771	Standard wrap element	12
23 278 31 103	Seal	37	49 000 51 851	Standard wrap element	11
23 278 31 104	Seal	37	49 000 52 102	Air/oil separator for vacuum pump	29
23 278 31 111	Seal	37	49 000 52 103	Air/oil separator for vacuum pump	32
23 278 31 991	Seal	37	49 000 52 105	Air/oil separator for vacuum pump	31
23 300 31 101	Seal	37	49 000 52 109	Air/oil separator for vacuum pump	29
23 303 31 112	Seal	37	49 000 52 114	Air/oil separator for vacuum pump	29
23 303 31 122	Seal	37	49 000 52 115	Air/oil separator for vacuum pump	29
23 303 31 131	Seal	37	49 000 52 171	Air/oil separator for vacuum pump	29
23 303 31 151	Seal	37	49 000 52 181	Air/oil separator for vacuum pump	31
23 303 31 161	Seal	37	49 000 52 201	Air/oil separator for vacuum pump	33
23 303 31 171	Seal	38	49 000 52 241	Air/oil separator for vacuum pump	29
23 303 31 191	Seal	38	49 000 52 271	Air/oil separator for vacuum pump	30
23 303 31 981	Seal	37	49 000 52 351	Air/oil separator for vacuum pump	29
23 320 31 131	Seal	38	49 000 52 352	Air/oil separator for vacuum pump	30
23 353 31 101	Seal	38	49 000 52 353	Air/oil separator for vacuum pump	31
23 353 31 121	Seal	38	49 000 52 501	Air/oil separator for vacuum pump	30
23 353 31 981	Seal	38	49 000 53 106	Air/oil separator for vacuum pump	30
23 403 31 101	Seal	38	49 000 53 107	Air/oil separator for vacuum pump	32
23 403 31 121	Seal	38	49 000 53 108	Air/oil separator for vacuum pump	29
23 403 31 131	Seal	38	49 000 53 112	Standard wrap element	11
23 479 31 111	Seal	38	49 000 54 102	Air/oil separator for vacuum pump	32
23 479 31 121	Seal	38	49 000 54 111	Air/oil separator for vacuum pump	31
23 600 31 102	Seal	38	49 000 54 121	Air/oil separator for vacuum pump	29
23 630 31 101	Seal	38	49 000 54 131	Air/oil separator for vacuum pump	31
49 000 50 391	Air/oil separator for vacuum pump	30	49 000 54 151	Air/oil separator for vacuum pump	31

List of contents acc. to part numbers

Part no.	Name	Page	Part no.	Name	Page
49 000 54 191	Air/oil separator for vacuum pump	31	49 301 53 401	Depth separator element	15
49 000 54 201	Air/oil separator for vacuum pump	31	49 301 53 532	Depth separator element	15
49 000 54 211	Air/oil separator for vacuum pump	30	49 301 55 151	Depth separator element	15
49 000 54 261	Air/oil separator for vacuum pump	32	49 301 55 361	Depth separator element	15
49 000 54 351	Air/oil separator for vacuum pump	30	49 302 53 131	Depth separator element	16
49 000 54 361	Air/oil separator for vacuum pump	30	49 302 53 171	Depth separator element	16
49 000 55 221	Air/oil separator for vacuum pump	32	49 302 53 321	Depth separator element	16
49 000 55 231	Air/oil separator for vacuum pump	33	49 302 53 451	Depth separator element	16
49 000 55 241	Air/oil separator for vacuum pump	31	49 302 55 131	Depth separator element	16
49 000 55 251	Air/oil separator for vacuum pump	30	49 302 55 151	Depth separator element	16
49 000 55 291	Standard wrap element	11	49 302 55 491	Depth separator element	17
49 000 55 301	Air/oil separator for vacuum pump	32	49 302 55 581	Depth separator element	16
49 000 55 341	Air/oil separator for vacuum pump	33	49 303 53 111	Depth separator element	17
49 001 52 108	Air/oil separator for vacuum pump	33	49 303 53 121	Depth separator element	17
49 001 52 110	Air/oil separator for vacuum pump	33	49 303 53 261	Depth separator element	17
49 001 52 151	Air/oil separator for vacuum pump	34	49 303 55 121	Depth separator element	17
49 001 52 171	Air/oil separator for vacuum pump	33	49 303 55 171	Depth separator element	17
49 001 52 172	Air/oil separator for vacuum pump	34	49 303 55 351	Depth separator element	17
49 001 53 105	Standard wrap element	11	49 303 62 101	Air/oil separator filter	25
49 001 53 112	Air/oil separator for vacuum pump	33	49 304 53 101	Depth separator element	17
49 001 53 161	Standard wrap element	11	49 304 55 241	Depth separator element	17
49 001 53 361	Standard wrap element	11	49 305 53 111	Depth separator element	17
49 001 54 100	Air/oil separator for vacuum pump	33	49 305 55 121	Depth separator element	17
49 001 54 105	Air/oil separator for vacuum pump	34	49 305 55 181	Depth separator element	17
49 001 54 281	Air/oil separator for vacuum pump	34	49 306 53 102	Depth separator element	17
49 001 55 171	Air/oil separator for vacuum pump	33	49 306 53 181	Depth separator element	17
49 001 55 181	Air/oil separator for vacuum pump	34	49 306 55 131	Depth separator element	17
49 001 55 191	Air/oil separator for vacuum pump	34	49 306 62 101	Air/oil separator filter	25
49 001 55 201	Air/oil separator for vacuum pump	33	49 307 53 102	Depth separator element	17
49 002 52 171	Air/oil separator for vacuum pump	34	49 307 55 111	Depth separator element	17
49 002 53 121	Standard wrap element	12	49 308 62 101	Air/oil separator filter	25
49 002 53 281	Standard wrap element	11	49 316 62 101	Air/oil separator filter	25
49 002 53 301	Standard wrap element	12	49 316 62 141	Air/oil separator filter	26
49 002 53 331	Standard wrap element	12	49 330 62 101	Air/oil separator filter	25
49 002 53 351	Standard wrap element	12	49 401 53 102	Depth separator element	15
49 002 53 371	Standard wrap element	12	49 403 53 121	Depth separator element	15
49 002 53 481	Standard wrap element	11	49 404 53 111	Depth separator element	15
49 002 53 491	Standard wrap element	12	49 406 55 101	Depth separator element	16
49 002 53 512	Standard wrap element	12	49 406 55 111	Depth separator element	16
49 002 55 171	Standard wrap element	12	49 407 53 101	Depth separator element	16
49 003 53 100	Standard wrap element	13	49 408 53 101	Depth separator element	16
49 003 53 122	Standard wrap element	12	49 409 53 101	Depth separator element	17
49 003 53 131	Standard wrap element	13	49 412 53 111	Depth separator element	17
49 003 53 332	Standard wrap element	13	49 412 55 101	Depth separator element	17
49 004 53 111	Standard wrap element	13	49 414 53 111	Depth separator element	17
49 004 53 151	Standard wrap element	13	49 418 53 111	Depth separator element	17
49 005 53 101	Standard wrap element	13	67 700 31 801	Filter head	39
49 006 53 100	Standard wrap element	13	67 730 31 861	Filter head	39
49 006 53 261	Standard wrap element	13	67 750 31 971	Filter head	39
49 007 53 102	Standard wrap element	13	LB 11 102/2	Air/oil separator box	21
49 007 53 121	Standard wrap element	13	LB 13 145/20	StarBox	22
49 013 53 111	Standard wrap element	13	LB 13 145/3	Air/oil separator box	21
49 300 53 222	Depth separator element	15	LB 1374/2	Air/oil separator box	21
49 300 55 171	Depth separator element	15	LB 719/2	Air/oil separator box	21
49 301 53 101	Depth separator element	16	LB 962/2	Air/oil separator box	21
49 301 53 131	Depth separator element	15	LB 962/20	StarBox	22
49 301 53 141	Depth separator element	15	W 11 102	Oil filter	43
49 301 53 151	Depth separator element	15	W 1170	Oil filter	43

List of contents acc. to part numbers

Part no.	Name	Page
W 712/65	Oil filter	43
W 719/37	Oil filter	43
W 920/40	Oil filter	43
W 920/51	Oil filter	43
W 930/35	Oil filter	43
W 940/55	Oil filter	43
W 950/24	Oil filter	43
W 962/14	Oil filter	43
W 962/18	Oil filter	43
WD 13 145/10	Oil filter	43
WD 13 145/14	Long-life oil filter	44
WD 13 145/8	Oil filter	43
WD 1374/6	Long-life oil filter	44
WD 962/21	Long-life oil filter	44

Conversion table

Volume flow m³/min → cfm

1 m ³ /min	=	35.3 cfm
1.7 m ³ /min	=	60.0 cfm
2 m ³ /min	=	70.6 cfm
3 m ³ /min	=	105.9 cfm
4 m ³ /min	=	141.3 cfm
4.5 m ³ /min	=	158.9 cfm
6 m ³ /min	=	211.9 cfm
8 m ³ /min	=	282.5 cfm
10 m ³ /min	=	353.1 cfm
12 m ³ /min	=	423.8 cfm
15 m ³ /min	=	529.7 cfm
18 m ³ /min	=	635.7 cfm
20 m ³ /min	=	706.3 cfm
21 m ³ /min	=	741.6 cfm
24 m ³ /min	=	847.6 cfm
25 m ³ /min	=	882.9 cfm
28 m ³ /min	=	988.8 cfm
32 m ³ /min	=	1130.1 cfm
37 m ³ /min	=	1306.6 cfm
40 m ³ /min	=	1412.6 cfm
42 m ³ /min	=	1483.2 cfm
50 m ³ /min	=	1765.7 cfm
60 m ³ /min	=	2118.9 cfm
80 m ³ /min	=	2825.2 cfm
100 m ³ /min	=	3531.5 cfm

Volume flow cfm → m³/min

25 cfm	=	0.7 m ³ /min
50 cfm	=	1.4 m ³ /min
75 cfm	=	2.1 m ³ /min
100 cfm	=	2.8 m ³ /min
150 cfm	=	4.2 m ³ /min
200 cfm	=	5.7 m ³ /min
250 cfm	=	7.1 m ³ /min
300 cfm	=	8.5 m ³ /min
350 cfm	=	9.9 m ³ /min
400 cfm	=	11.3 m ³ /min
450 cfm	=	12.7 m ³ /min
500 cfm	=	14.2 m ³ /min
550 cfm	=	15.6 m ³ /min
600 cfm	=	17.0 m ³ /min
650 cfm	=	18.4 m ³ /min
700 cfm	=	19.8 m ³ /min
750 cfm	=	21.2 m ³ /min
800 cfm	=	22.7 m ³ /min
850 cfm	=	24.1 m ³ /min
900 cfm	=	25.5 m ³ /min
950 cfm	=	26.9 m ³ /min
1000 cfm	=	28.3 m ³ /min
1500 cfm	=	42.5 m ³ /min
2000 cfm	=	56.6 m ³ /min
3000 cfm	=	85.0 m ³ /min

Pressure bar → psi

0.1 bar	=	1.45 psi
0.12 bar	=	1.74 psi
0.5 bar	=	7.25 psi
1 bar	=	14.5 psi
2 bar	=	29 psi
2.5 bar	=	36.25 psi
3 bar	=	43.5 psi
5 bar	=	72.5 psi
10 bar	=	145 psi
14 bar	=	203 psi
20 bar	=	290 psi
25 bar	=	362.5 psi
30 bar	=	435 psi
35 bar	=	507.5 psi
40 bar	=	580 psi
100 bar	=	1450 psi
200 bar	=	2900 psi
300 bar	=	4350 psi
400 bar	=	5800 psi

Length mm → inch

10 mm	=	0.39 inch
20 mm	=	0.79 inch
30 mm	=	1.18 inch
40 mm	=	1.57 inch
50 mm	=	1.97 inch
60 mm	=	2.36 inch
70 mm	=	2.76 inch
80 mm	=	3.15 inch
90 mm	=	3.54 inch
100 mm	=	3.94 inch
150 mm	=	5.91 inch
200 mm	=	7.87 inch
250 mm	=	9.84 inch
300 mm	=	11.81 inch
350 mm	=	13.78 inch
400 mm	=	15.75 inch
450 mm	=	17.72 inch
500 mm	=	19.69 inch

Temperature °C → °F

-30 °C	=	-22.0 °F
-10 °C	=	14.0 °F
0 °C	=	32.0 °F
10 °C	=	50.0 °F
30 °C	=	86.0 °F
50 °C	=	122.0 °F
80 °C	=	176.0 °F
100 °C	=	212.0 °F
120 °C	=	248.0 °F

Further information material (selection)

Compressor animation

DVD
Order No.
19 943 50 100
multilingual

CD-ROM
Order No.
19 943 50 200
multilingual



MANN-FILTER products for the filtration of compressed air

Catalogue
order no.
W9 942 20 100 de
W9 942 20 101 en

Further languages available
on request.



Air cleaners

Europiclon®
NLG
Vacuum air cleaners

Catalogue
order no.
19 941 10 100 de
19 941 10 101 en

Further languages available
on request.



Filters for liquids

Spin-on filters
Fuel filters
In-line filters

Catalogue
order no.
19 942 10 100 de
19 942 10 101 en

Further languages available
on request.

- MANN+HUMMEL company
- Joint venture company



MANN+HUMMEL Group

The MANN+HUMMEL Group is an international company with its headquarters in Ludwigsburg, Germany. The group employs approx. 11,500 people worldwide at more than 41 locations.

The company develops, produces and sells technically complex components for the automotive and other

industries. A key area is high quality filtration products for vehicles, engines and industrial applications. The OEM business with global market leaders and producers of vehicles, machines and installations defines the quality and performance of the group. Filters for the international aftermarket are sold under numerous inter-

national brands as well as under the MANN-FILTER brand.

MANN+HUMMEL Industrial Filters

The Industrial Filters Business Unit with its headquarters in Speyer, Germany is specialised in meeting the requirements of off-highway

vehicle and engine applications, compressed air and vacuum technology, mechanical engineering and plant construction. For these and other industrial fields MANN+HUMMEL Industrial Filters offers high performance products for the filtration and separation of air, gases and liquids.



MANN+HUMMEL GMBH, Business Unit Industrial Filters
 67346 Speyer, Germany, Telephone +49 (62 32) 53-80, Fax +49 (62 32) 53-88 99
 E-Mail: if.info@mann-hummel.com, Internet: www.mann-hummel.com