





## Introduction

The CANplus<sup>™</sup> 600 (CP600<sup>™</sup>) control panel is an economical platform to monitor and control electronically governed diesel engines. Graphical gauge pages or a single large analog gauge are displayed on the 4.25" diagonal LCD. Virtually any SAE J1939 parameter reported by the ECU (Engine Control Unit) can be displayed including RPM, coolant temperature, oil pressure, engine hours, voltage and diagnostic codes. The trans-reflective, backlit display is clearly readable in both bright sunlight as well as total darkness and housed in a rugged IP67 rated housing.

Current alarm conditions are displayed in plain language on popup messages and can be viewed in the alarm list. Various diagnostic screens allow detailed investigation of the CANbus data stream. By accessing the **Configuration Menu**, users can customize displayed data to show metric or US units, display language and various other parameters such as the full-scale reading of gauges.

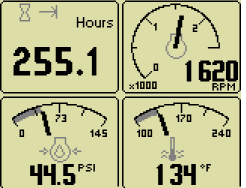
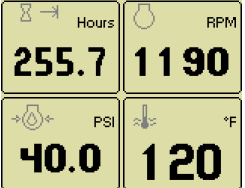
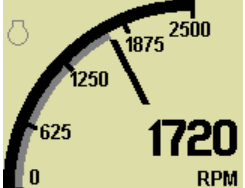
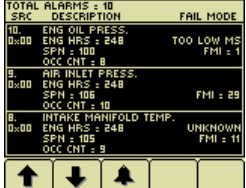
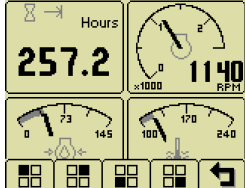

Five buttons access a context dependent **button bar** when any button from 1 to 4 is pressed. The graphical menu structure uses easily understood icons to indicate the button's current function. After 5 seconds of inactivity the button bar disappears.

Button 1 	Button 2 	Button 3 	Button 4 	Button 5 
<b>Analog Gauge Pages</b>  Repeated presses cycle through four pages of analog gauges (16 total).	<b>Digital Gauge Pages</b>  Repeated presses cycle through four pages of digital gauges (16 total).	<b>Single Analog Gauge</b>  Repeated presses cycle through various available analog gauges.	<b>Active Alarm Page</b>  Displays active alarms including a plain language description.	<b>Gauge Adjust</b>  Allows configuring the parameters used by gauge pages.
				

---

**Note**

Most problems with electronically controlled engines can be pinpointed via ECU diagnostic messages. Use the display or ECU diagnostic tool to view fault codes.

All engine state information and diagnostic codes displayed by the CANplus display are provided via the CANbus.

---

**Throttle Control**

The standard ramp throttle uses a momentary rocker switch to adjust the integral throttle control. All throttle commands are sent directly to the engine using CANbus throttle control.

---

**Note**

Throttle control requires CANbus throttling to be enabled in the ECU. CANbus throttling is also identified as Torque Speed Control and TSC1.

Rotary potentiometers are available for ECUs that do not support CANbus throttle control.

---

Other throttle options include digital rotary hand throttle, two-state throttle rocker switch (idle/run) or three-state throttle rocker switch (idle/intermediate/run). The three-state throttle rocker switch can be used in conjunction with the digital rotary hand throttle to adjust the intermediate speed.

**Service Timers**

The CP600 panel provides sixteen (16) service timers to alert the operator to needed maintenance. The time interval for each of the timers can be adjusted in 10 hour increments. A popup message is displayed after the display self test if a timer has expired alerting the user that service is required. The popup message continues to be displayed at power up until the timer is disabled or reset.

**Telemetry Option**

The optional telemetry system provides a variety of features to protect and support your equipment investment. Remote monitoring can alert maintenance requirements, operational problems, improper operation and theft. The Web-browser interface allows monitoring an entire fleet of equipment in a central location.

**LED Option**

Four optional bright LEDs indicate Power, Preheat, Stop and Warning status. These LEDs are controlled directly by the ECU.

---

**Warning**

When replacement parts are required, LOFA Industries recommends using replacement parts supplied by LOFA or parts with equivalent specifications.

Failure to heed this warning could lead to premature failure, product damage, personal injury or death.

---

### ***Important Safety Information***

---

The warnings in this publication are not all inclusive.

LOFA Industries cannot anticipate every potential hazard.

Appropriate safety rules and precautions should be followed with any tool, work method or operating procedure.

Improper procedures, tools and materials may cause damage or make the equipment unsafe to operate.

Only persons with appropriate training, skills and tools should perform these functions.

Improper operation, maintenance or repair of this product can be dangerous and may result in injury or death.

Do not operate or perform any maintenance or repair on this product until all operation, maintenance and repair information is read and understood.

The information, specifications and illustrations in this publication are based on information available at the time of publication.

All items are subject to change at any time without notice.

---

## Operation

Turning the control system key to the run position energizes the ECU and displays a start-up screen while the display performs a self test. If the display beeps for longer than 1 second, it indicates a self test fault. Users can attempt to rectify the fault by restoring factory defaults (see *Configuration Menu* for details). Contact LOFA Industries for assistance if the fault persists.

After the start-up screen disappears, the display shows readings on its virtual gauges. Initially the analog gauges are displayed but the display uses the screen last displayed on subsequent startups (see *Preferred Screen Store* for details).

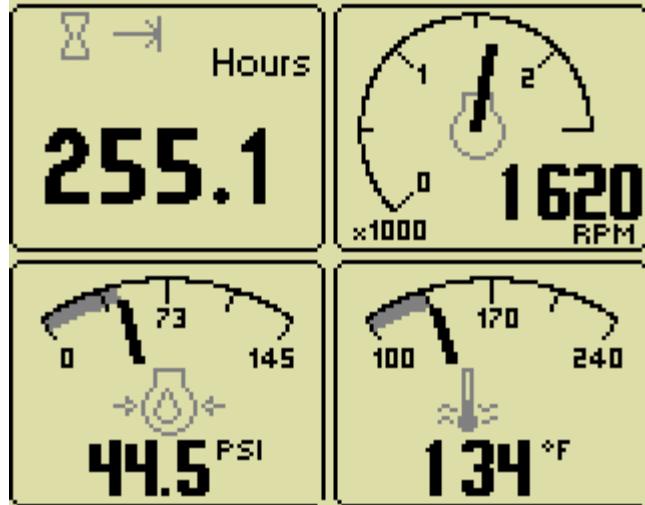

If the ECU is preheating when the key switch is turned to the run position, the optional Preheat LED is illuminated. Preheat time varies with atmospheric and engine conditions. After waiting for the Preheat LED to extinguish, the engine is cranked by turning and holding the key switch in the start position until the engine starts.

### Note

---

The ECU will not preheat unless conditions warrant. If necessary, starting the engine may be attempted by turning the key to the start position without waiting for preheat to expire.

---

The key switch is spring loaded to return automatically to the run position when released. The key switch is equipped with a mechanical start locking device. An attempt to re-crank the engine can only be made by turning the key switch to the off position to reset the start locking mechanism.

## CANplus Display

Soft buttons simplify the operator interface by displaying a **button bar** above the buttons when any of the first 4 buttons (buttons 1 to 4, starting from the left) are pressed. Icons on the button bar representing the current function of each button. The button bar disappears after 5 seconds if no further buttons are pressed.

### Note

---

Different software versions may have slightly different displays.

---

## Analog Gauge Pages

**Analog Gauge Pages** provide four independent pages of analog gauges. To enable Analog Gauge Pages, press any of the first 4 buttons to show the top level button bar and then press button 1 . Alternate pages are selected by repeated pressing of button 1. The four standard gauge pages are shown below.

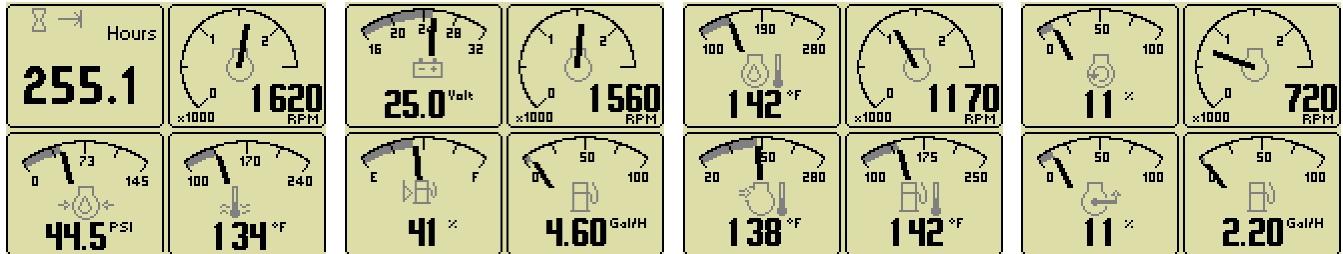







### Note

---

Engine Hours are displayed as a digital value even on Analog Gauge Pages.

---

All 16 gauges may be configured by the user to create an application-specific view of CANbus data. Gauges are changed via **Adjust Mode**, accessed by pressing button 5  when the button bar is visible.

In the adjust mode a new button bar is displayed identifying the new button functions. Button 1  corresponds to the upper left gauge, button 2  to the upper right gauge, button 3  to the bottom left gauge and button 4  to the bottom right gauge. Successive presses of any of the buttons selects a different parameter to display for the corresponding gauge. Adjust Mode is exited by pressing button 5  and configuration is stored even when power is removed.

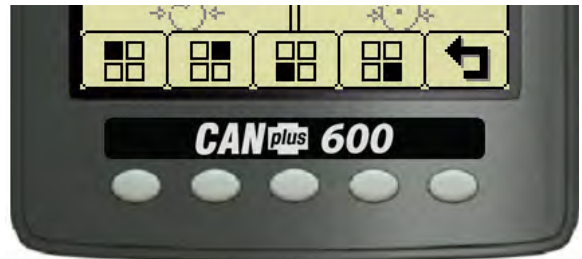

### Note

---

Gauge selections are limited to the data currently being received.  
 Gauge pages can be configured in Demo mode to select any supported parameter.  
 See **Data Parameters Monitored** for a complete list of available parameters.

---

Adjust Mode can be disabled once gauge pages have been configured to prevent accidental changes (see **Configuration Menu**).

## Digital Gauge Pages

**Digital Gauge Pages** display the same data as the Analog Gauge Pages but in digital format. To enable Digital Gauge Pages, press any of the first 4 buttons to show the top level button bar and then press button 2 . Alternate pages are selected by repeated pressing of button 2. The four standard gauge pages are shown below.

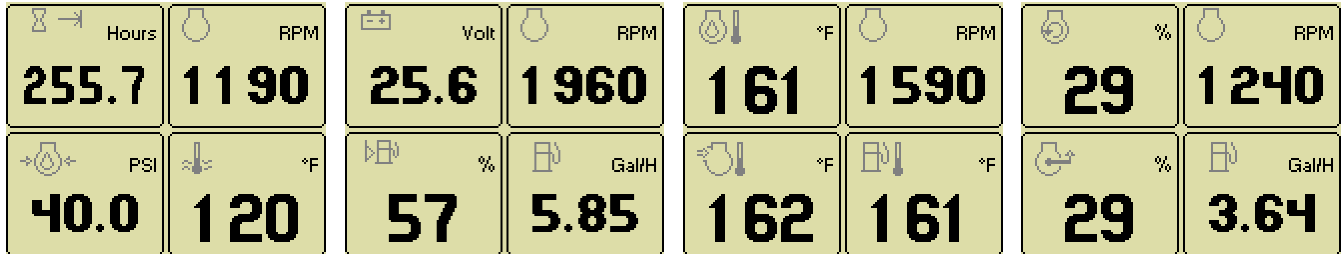

### Note

---

The 16 gauges are the same for Analog and Digital Gauge Pages. Changes in either Analog Gauge Pages or Digital Gauge Pages affect the same gauge in the other mode.

---

## Single Analog Gauge

**Single Analog Gauge** uses the entire display for a single large analog gauge. This mode is enabled by pressing any of the first 4 buttons to show the top level button bar and then press button 3 . The gauge displayed is selectable by repeatedly pressing button 3 while in the Single Analog Gauge mode while the menu bar is visible.

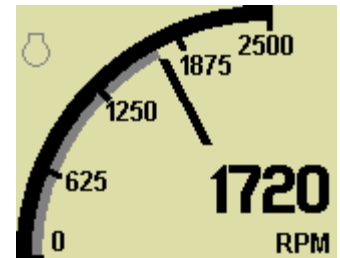

## Active Alarms

A flashing popup window is overlaid on the current screen when an active alarm is received. The popup includes a plain language description in addition to the standard SPN-FMI pair defined by the SAE J1939 standard. Additionally the beeper sounds as an audible cue.

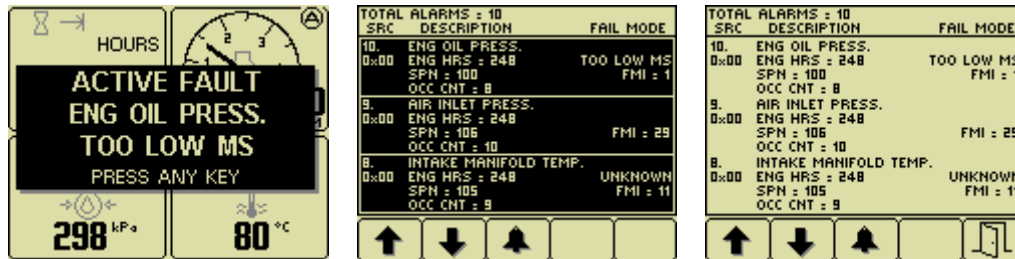





Example alarm message, plus alarm list screens showing unacknowledged conditions and acknowledged alarms.

After acknowledgement, the exit button  becomes active.

### Note

Standard J1939 abbreviations are used for alarms.  
**MS** = Most Severe, **MOD**= Moderately Severe, **LS** = Least Severe.

## Alarm List



The Alarm List is accessed by pressing any button while an alarm popup is displayed or by pressing any of the first 4 buttons to show the button bar and then button 4 . Alarms not yet acknowledged are shown in grey on black while acknowledged alarms are shown in black on grey. The list also indicates when the alarm occurred if engine hours are available. The most recent alarm is displayed at the top of the list. The list can be scrolled using buttons 1  and 2  and alarms acknowledged by pressing button 3 . The Alarm List can be closed by pressing Button 5  once the alarms are acknowledged.

An alarm indicator  is displayed near the upper right corner of the display as long as alarms are active. The indicator and alarm messages in the list are automatically removed when the alarm is no longer received for a few seconds.

## Configuration Menu

This *Configuration Menu* allows the user to set various operating parameters such as US or metric units, scale limits for tachometer and service timers. The configuration menu is entered by pressing and holding button 5 (the right hand button) in any mode for at least 3 seconds. If PIN entry is enabled the correct PIN must be entered to access the configuration menu. The top level configuration menu is displayed as shown.

Buttons 1  and 2  allow you to choose from *Display, System, Throttling, Telemetry* or *Db Viewer*.

Pressing button 4  selects the chosen menu item indicated in bold and the arrow . Each item is described in detail on the following pages. Settings are automatically stored when exiting the current menu even when power is removed.

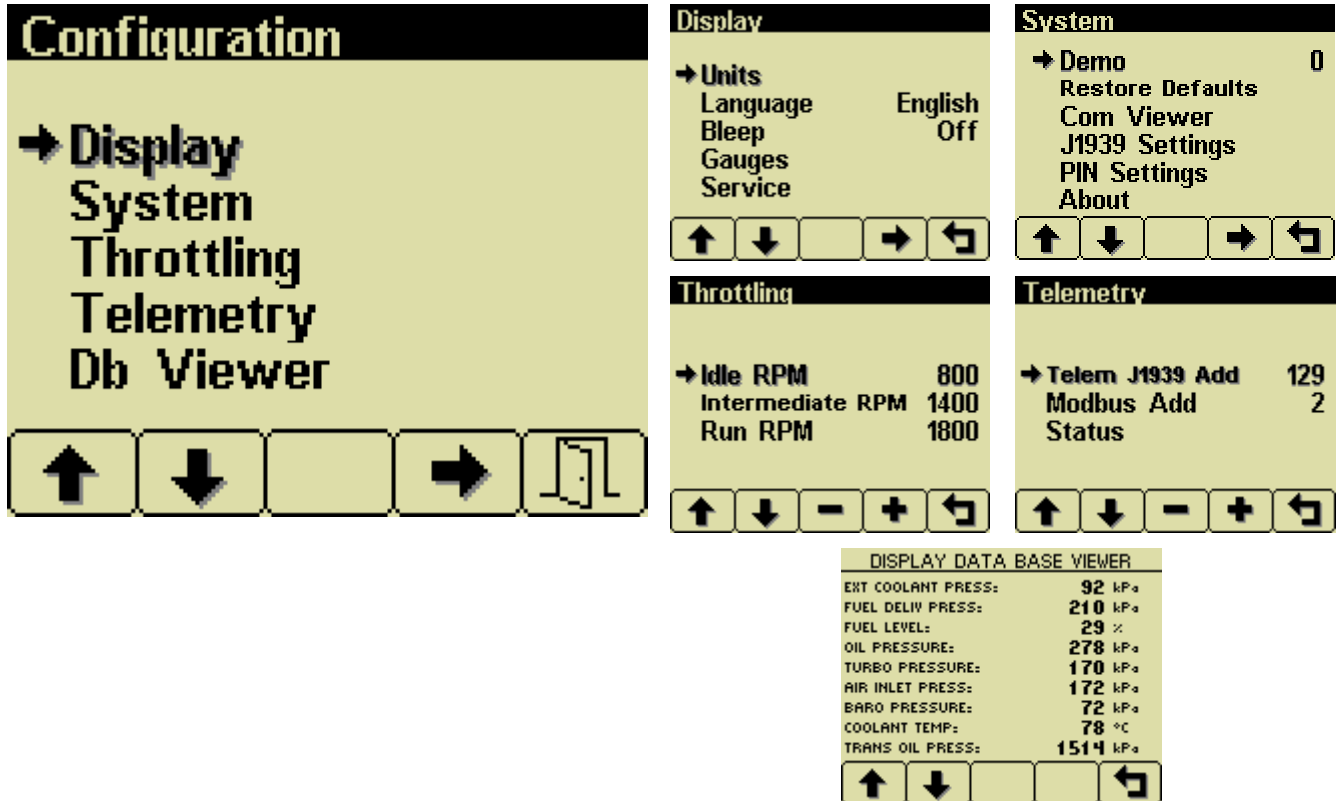

The top level Configuration menu and its five choices.

Pressing Button 4  selects the highlighted menu item.

Button 5  exits the configuration mode.

### Note

Most configuration changes take affect immediately.  
Some such as Idle RPM take affect on the next power up.



## Display Menu

The *Display Menu* allows the user to configure items affecting how information is displayed.

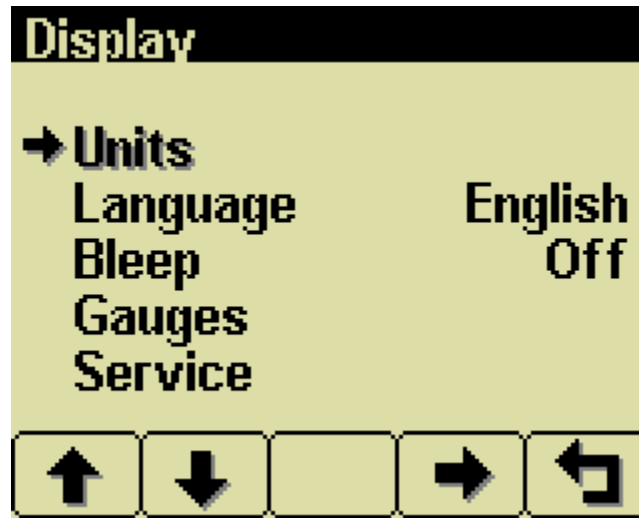

### Units Menu

This menu allows the user to set the units used for speed, distance, pressure, volume and temperature independently.

Button 4  changes the selected value.

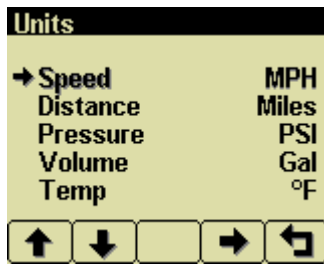

- Speed** MPH (miles per hour)  
km/h (kilometers per hour)  
Knts (knots)
- Distance** Miles  
km (kilometers)  
NM (nautical miles)
- Pressure** PSI (pounds per square inch)  
bar (barometric units)  
kPa (kilopascals)
- Volume** Gal (US gallons)  
IGal (Imperial gallons)  
Liters
- Temperature** °F (Fahrenheit)  
°C (Celsius).

### Language Menu

This menu allows the user to choose between English, Swedish, French, German, Spanish, Italian, Dutch and Portuguese. The currently selected value is indicated by the check mark .

Button 4  selects the highlighted value.





### Bleep

The soft buttons emit an audible beep when this item is On. Button beep is disabled by setting this item to Off. The audible beep still sounds when an alarm occurs.

## Gauges Menu

This menu allows the user to configure aspects of the gauges displayed on the display.

Button 3  selects the previous value while

Button 4  selects the next value of the highlighted item.

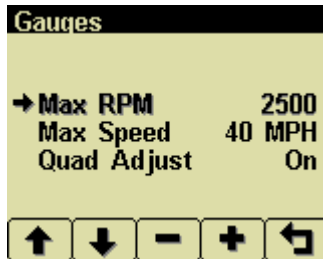

### Max RPM

Sets the maximum RPM indicated by the tachometer gauge.

**RPM** 2500, 3000, 3500, 4000, 4500, 5000, 6000, 7000, 8000 or 9000



### Max Speed

Sets the maximum speed indicated by the speedometer gauge.

**MPH** 15, 20, 25, 30, 35, 40, 45, 50, 55, 60, 70, 75, 80, 85, 95 or 100

**km/h** 20, 30, 40, 50, 60, 70, 80, 90, 100, 110, 120, 130, 140, 150 or 160

### Quad Adjust

Allows the user to disable Adjust Mode of the Analog and Digital Gauge Pages. Button 3  disables while Button 4  enables Quad Adjust.

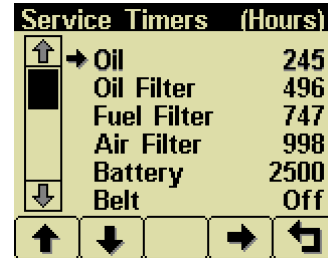

## Service

Sets the sixteen (16) service intervals in hours and resets the service timer. Setting the service interval to 0 disables the timer and the word **Off** is displayed.

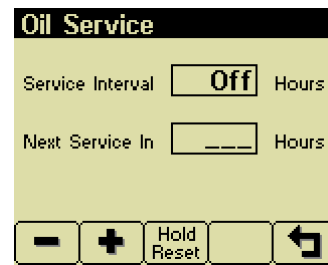

Pressing Button 4  allows adjusting the selected service timer.



Button 1  decreases the service interval time while Button 2  increases the service interval time in 10 hour increments. Holding Button 3  for approximately 3 seconds resets *Next Service In* to the current service interval.

### Note

It is not possible to reset the service timer if engine hours are not being received by the display.

## System Menu

The *System Menu* allows the user to configure items affecting how the system functions.

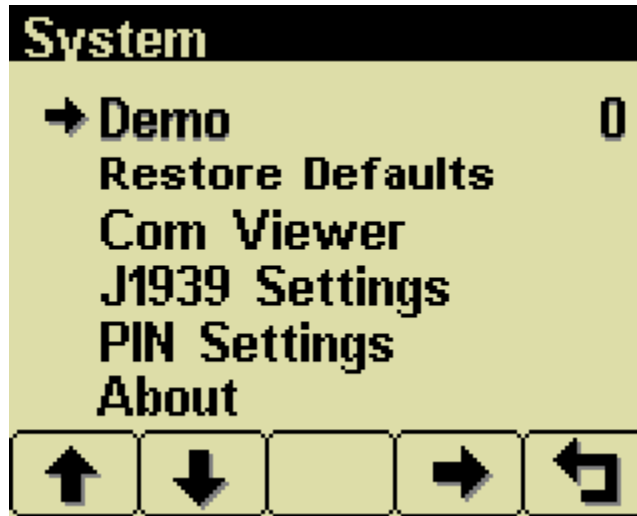

The default settings are:

### Demo

The display supports several demo modes to operate with simulated data. Mode 1 simulates speed data and engine parameters. Mode 2 only simulates engine parameters. Mode 3 simulates speed data, engine parameters and alarms. Mode 0 disables Demo Mode. Demo is automatically set to 0 (Off) if live data is received.

### Restore Defaults

This allows resetting all configuration information to default US  or Metric  units. Additionally the display is reset to the initial configuration.

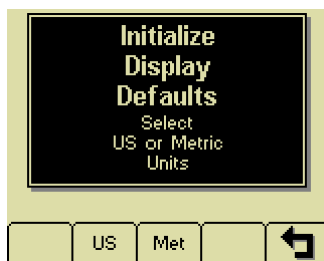

Setting	US	Metric
Language	English	
Button Beep	On	
Service Timers	Off	
Display Mode	Analog Gauges	
Gauge Pages	Defaults	
Quad Adjust	On	
Demo Mode	0 (Off)	
Source Address	0	
Display CAN Address	40	
Alarm Filter	Glb	
SPN Version	1	
Speed Source	Auto	
PIN Entry	Off	
PIN	1111	
Max Gauge RPM	2500	
Max Gauge Speed	40 MPH	60 KmH
Speed Units	MPH	KmH
Distance Units	Miles	Km
Pressure Units	PSI	kPa
Volume Units	Gal	L
Temperature Units	°F	°C

## Com Viewer

Displays last CANbus messages received and engine configuration transmitted by the ECU.

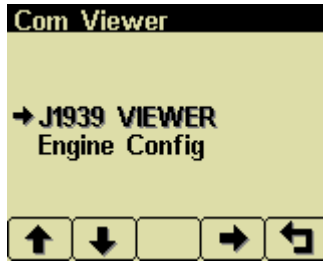

## J1939 Viewer

This screen provides a hexadecimal dump of the last messages received on the CANbus. This viewer displays the raw data. To see the decoded data use the *Db Viewer*.

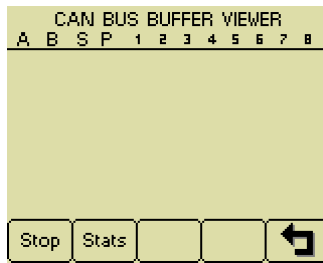

Button 1 **Stop** freezes the display while button 2 **Stats** shows CANbus data statistics screen.

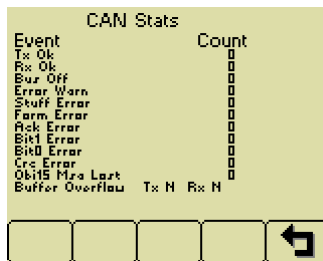

## Engine Config

This screen displays the engine configuration information received from the ECU.

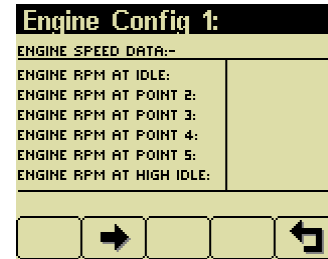

Button 2 **→** selects the next page of engine configuration while button 1 **←** select the previous page.

## J1939 Settings

This screen allows adjustments specific to the J1939 data link.

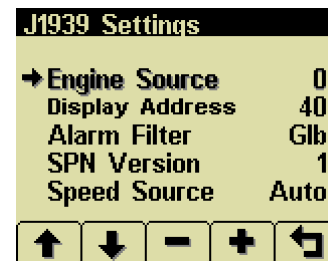

## Engine Source

Selects which source the display listens to for gauge data. Every device on a J1939 network has a unique address (in the range 0-254) to which the display can choose to listen. The display listens to a single data source; usually Engine 1 at address 0.

### Note

Incorrectly configuring the Engine Source address will result in no data available for display.

## Display Address

As mentioned previously, every device has a unique address and the display is no different. In single engine setups the default display address is 40 (SAE recommendation).

### Warning

Incorrectly configuring the Display Address can result in data collisions on the CANbus.

## Alarm Filter

This setting specifies whether the display will display alarms from all sources (*Glb* or global) or only the source address specified in the *Engine Source* setting (*Src* or source).

## SPN Version

Selects the default SPN (Suspect Parameter Number) conversion method version to 1, 2 or 3. Version 4 is automatically detected, but older engines will have to be set to 1, 2 or 3.

### Note

Consult your engine supplier to establish the appropriate SPN conversion method version if alarm data is incorrect.

## Speed Source

There are 3 sources of speed data the display can decode. The settings for this parameter are *AUTO*, *NMEA*, *WHEEL*, *NAV* and *OFF*. *AUTO* prioritizes the sources (highest to lowest); *NMEA*, *WHEEL* (PGN 65265), *NAV* (PGN 65272). The selection can be forced to one of the available sources by selecting it explicitly. Selecting *OFF* stops the display listening to any source of speed data.

## PIN Settings



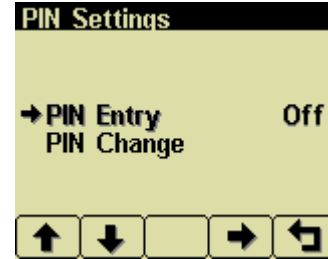

By default PIN security is disabled. The user is prompted to enter a PIN every time the *Configuration Menu* is accessed after this feature is enabled.

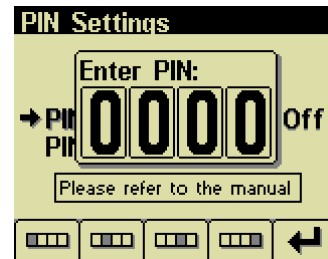

## PIN Entry

This allows turning PIN Entry *On* or *Off*. To enable the PIN entry feature select *PIN Settings* and press button 4  to enable. The current pin must be entered (default is 1111) as a security feature. Once the PIN has been entered the feature is enabled. PIN Entry is disabled by setting PIN Entry to *Off*.



The digits of the PIN are entered by using the buttons corresponding to the digits of the PIN. Button 1  adjusts the first digit of the PIN. Button 2  adjusts the second digit, button 3  the third digit and button 4  the fourth digit. The PIN is entered using button 5 .

## PIN Change

This allows changing the PIN. The user is prompted for the current PIN

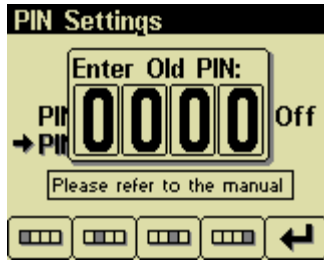

The user is prompted for the new PIN.

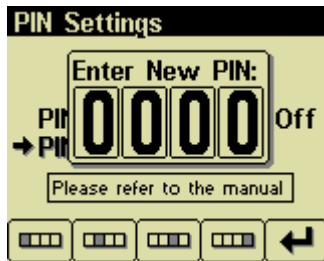

The new PIN must be confirmed before the PIN is changed.

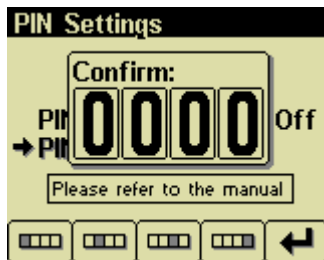

If the new PINs match a confirmation screen is displayed.

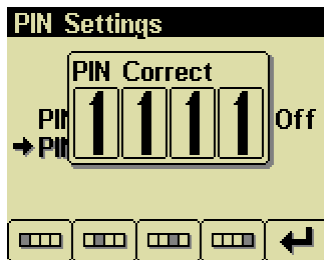

If the two PINs entered do not match an error message is displayed and the PIN is unchanged.

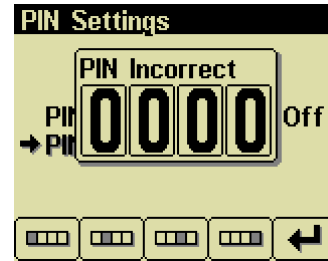

## About

Displays the following product information:



ID/Build	Serial number of the display
EEPROM	Number of writes on EEPROM
PART No	Unit part number
VERS	Software version number
CHK	Flash memory checksum
SOURCE	The source of received data
LIB1	Low level system library version
LIB2	Low level Graphical Display Interface library version (if used)

## Note

This screen can not be exited until the checksum calculation is complete. Checksum calculation takes approximately 10 seconds and is complete when the checksum value changes from "Calculating..." to a hexadecimal value such as "0x704E - OK"

## Throttling Menu

The throttling menu allows the user to configure throttle control.



### **Idle RPM**

Selects the RPM the control system will request for idle speed. Idle can be set to compensate for parasitic loads such as hydraulic pumps or compressors.

#### **Note**

---

The minimum engine RPM is set by the ECU. Requesting a lower speed causes the engine to run at the ECU minimum RPM.

---

### **Intermediate RPM**

Selects the RPM the control system will request for intermediate speed.

#### **Note**

---

Intermediate RPM is only used with the optional three-state throttle switch.

---

### **Run RPM**

Selects the RPM the control system will request for run speed.

#### **Note**

---

Run RPM is only used with the optional two-state or three-state throttle switch.

---

## Telemetry Menu

This menu allows configuring the optional telemetry system.

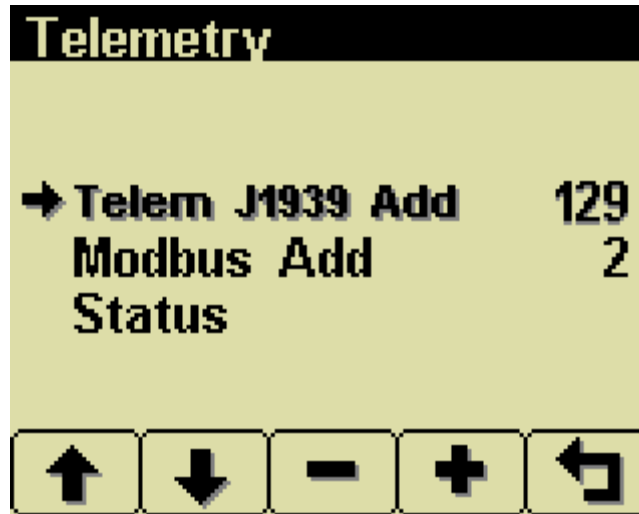

### Telem J1939 Address

Defines address the telemetry module is using for CANbus communications.

#### Note

The display will be unable to communicate with the telemetry module if this address is incorrect.

### Modbus Address

Selects the Modbus slave address the telemetry module will use for Modbus communications.

### Status

Displays telemetry and modem status information retrieved from the telemetry module:

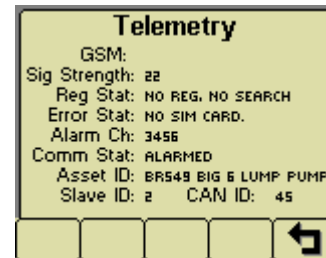

GSM	GSM ID
Sig Strength	0 to 50, 99 if error
Reg Stat	GSM Registration Status
Error Stat	Error status
Alarm Ch	Alarm channel number
Comm Stat	Communication Status
Asset ID	31 character Asset ID



## Db Viewer

The Database Viewer displays and decodes all data monitored by the display. This diagnostic tool allows viewing data not normally displayed.

DISPLAY DATA BASE VIEWER	
EXT COOLANT PRESS:	16.4 PSI
FUEL DELIV PRESS:	30.5 PSI
FUEL LEVEL:	60 %
OIL PRESSURE:	49.2 PSI
TURBO PRESSURE:	29.0 PSI
AIR INLET PRESS:	28.0 PSI
BARO PRESSURE:	14 PSI
COOLANT TEMP:	182 °F
TRANS OIL PRESS:	234 PSI

↑	↓			↶
---	---	--	--	---

The list can be scrolled using buttons 1  and 2  and closed by pressing Button 5 .

### Note

The Database Viewer is always in English regardless of language selected.

## Preferred Screen Store

The display automatically stores the current screen as the preferred page after a delay of approximately 15 seconds. The display will use the last stored screen on the next power-up.

### Note

Selecting *Restore Defaults* restores the Analog Gauge Pages and default gauges.

## Popup Messages and Alerts

### Service Required

Users can set up to sixteen service timers in hours in the Configuration menu. The SERVICE REQUIRED popup is displayed at power up when one or more service timers has expired. Pressing any button removes the popup. If no button is pressed the popup closes in approximately 5 seconds.

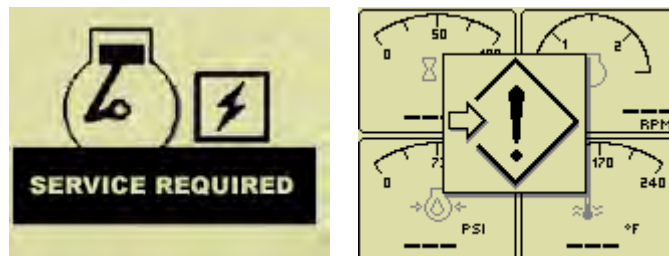

Pop-up warnings of service required and data communications failure.

## Data Communications Failure

The data communications failure popup icon flashes if the display does not detect data. The warning disappears and normal operation resumes once data is detected.

### Note

---

Incorrectly configuring the Engine Source address will result in no data available for display.

---

## Data Not Available

Gauges and the Db Viewer will display  if the desired data is not available. The display value returns to normal when parameter data is received.

## Adjusting Lighting and Contrast

Pressing button 5 (the right-hand button) when there is no menu bar opens the lighting and contrast menu bar. The display has a number of back-lighting levels that allow the display to be read in the dark. The level is adjusted by pressing buttons 1 decrease or button 2 to increase  illumination.

Contrast is adjusted in the same manner using buttons 3 and 4 .

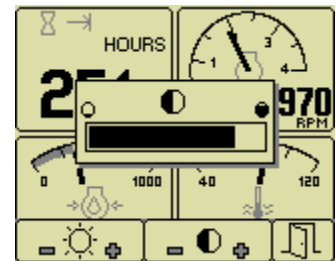

### Note

---

The display adjusts the contrast with ambient temperature.  
Manual contrast adjustments are only necessary with extreme climate change.

---

The menu is exited by pressing button 5 . The lighting and contrast settings are retained after the unit is switched off.

### Note

---

If the contrast has been adjusted poorly, the factory setting is restored by pressing buttons 1 thru 4 simultaneously. This action does not change other user-configured settings.

---

## Optional Indicators

### ***Power LED (Green)***

A solidly illuminated *Power* LED indicates the keyswitch is in the on position.



### ***Preheat LED (Amber)***

A solidly illuminated *Preheat* LED indicates the engine is preheating. When the LED extinguishes, the preheat period is complete and the engine may be cranked.

#### **Note**

---

The CANplus display only reports when the ECU is requesting preheat.  
Cold starting aids may not be installed in all engine configurations.

---



### ***Engine Stop LED (Red)***

A solidly illuminated *Engine Stop* LED indicates the ECU has stopped the engine due to a fault.

#### **Note**

---

ECU programming determines the response to warnings and failures.  
Typically the ECU can be programmed to shutdown, derate or run to failure.  
The CANplus display only reports CANbus conditions.

---



### ***Warning LED (Amber)***

A solidly illuminated *Warning* LED indicates a warning reported on the CANbus.

## Typical J1939 Wiring Topology

Most electronically governed engine installations include a harness with built in J1939 backbone. Use twisted shielded pair with a drain wire for CANbus wiring terminated with  $120\Omega$  resistors at each end. The maximum length for the bus is 131 feet (40 m) and stubs should not exceed 39 inches (1m) in length.

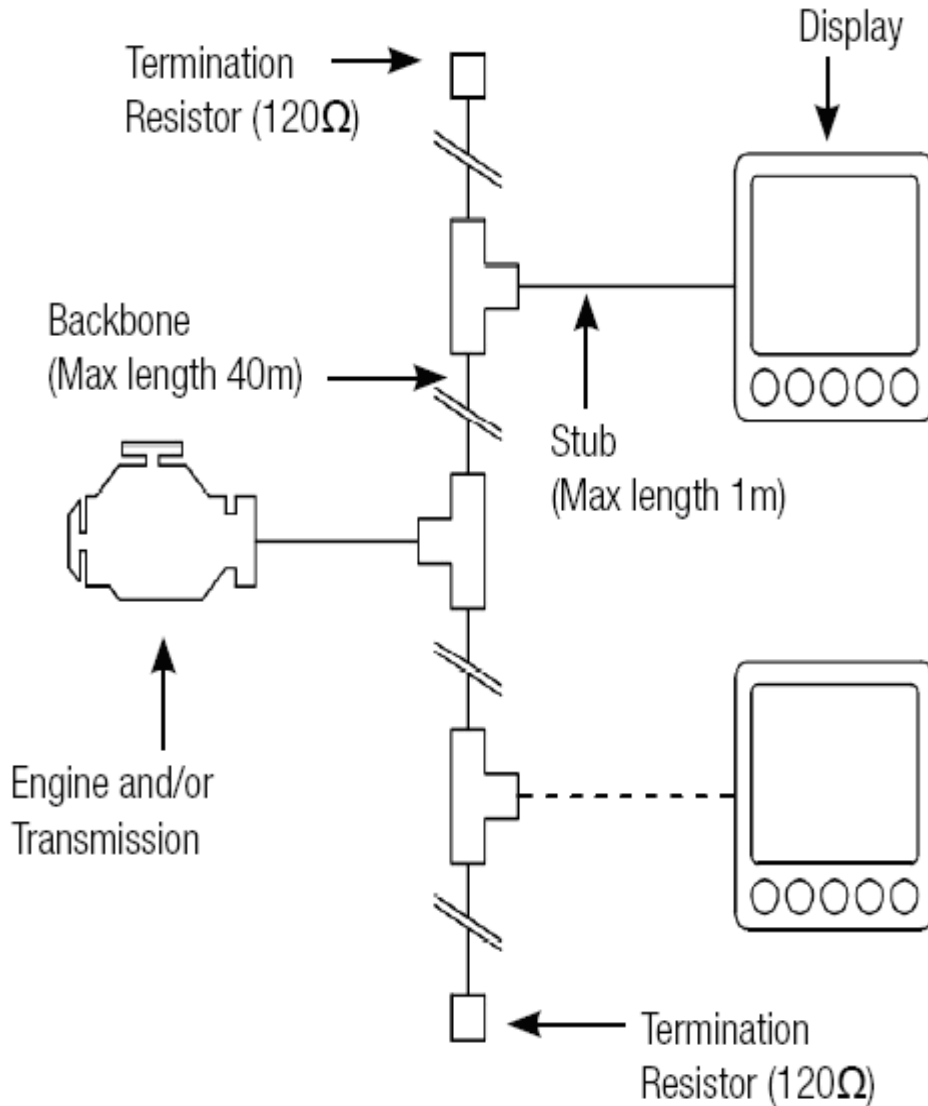

## **Harness**

### ***Sealed Connectors***

The provided Deutsch sealed weather-proof plug includes a locking ring device which must be turned counter clockwise to separate the connectors. To positively seat the connectors the locking ring is turned clockwise.

#### **Warning**

---

LOFA does not recommend using dielectric grease or sealant with sealed connectors.  
These chemicals may cause seal damage and allow water entry.

Use LOFA provided cavity plugs to seal the connector if wires are removed.

---

### ***Unsealed Connectors***

For unsealed connectors exposed to the elements, LOFA recommends using dielectric grease to protect contacts.

#### **Warning**

---

LOFA does not recommend using sealant with unsealed connectors.  
Sealant traps moisture in the connector and encourages corrosion.

---

### ***Harness Routing***

The minimum routing radius of the wiring harnesses should be at least two times the diameter of the wiring harness. Bends should be avoided within 1 inch (25 mm) of any connector in order to avoid seal distortion allowing moisture to enter the connector.

## **Battery Circuit Requirements**

### **Warning**

---

Improper wiring can cause electrical noise, unreliable operation and may damage the control system or other components. All power connections must be free from foreign materials, including paint, which may interfere with proper connection.

A reliable dedicated power circuit must be provided for the control system.

LOFA recommends the power connection be made directly to the battery.

**Grounding through frame members is not recommended!**

All circuit paths must be capable of carrying any likely fault currents without damage.

Do not reverse the battery polarity. Attempting to crank the engine when the polarity of the battery connections is reversed may damage the control system.

---

### **Battery Positive Connection**

The electronic control system operates on either a 12 VDC or 24 VDC electrical systems. The unswitched battery positive connection to the control system is made at the weather proof connector. The control system provides switched positive battery protected by solid-state MOSFETs. These outputs include integral protection against overloads and short circuits.

An integral 40 AMP slow blow fuse protects the unswitched battery positive circuit. Powering the control system through dedicated circuits reduces the possibility of system damage.

### **Warning**

---

Disconnecting the battery while the engine is running may damage electrical components.

When using a battery disconnect switch, LOFA recommends using a 2 pole switch to disconnect both the battery and alternator output.

---

### **Note**

---

A maximum of three ring terminals should be connected to a power stud in order to ensure integrity of the connection.

The use of more than three terminals can cause the connection to become loose.

---

### **Voltage Drop**

If control system voltage drops below 6 volts for more than one tenth of a second, the control system may reset causing the self test to reactivate. Resetting the control system is equivalent to quickly turning the key switch to off and back to run without starting the engine. Voltage drops can be caused by a discharged battery, transients from external equipment, improper wire sizes, faulty wiring or nearby lightning strikes.

## Suppression of Voltage Transients (Spikes)

### Warning

---

The installation of voltage transient suppression at the transient source is required.

---

LOFA follows SAE recommended electrical environment practices.

---

Inductive devices such as relays, solenoids and motors generate voltage transients and noise in electrical circuits. Unsuppressed voltage transients can exceed SAE specifications and damage electronic controls.

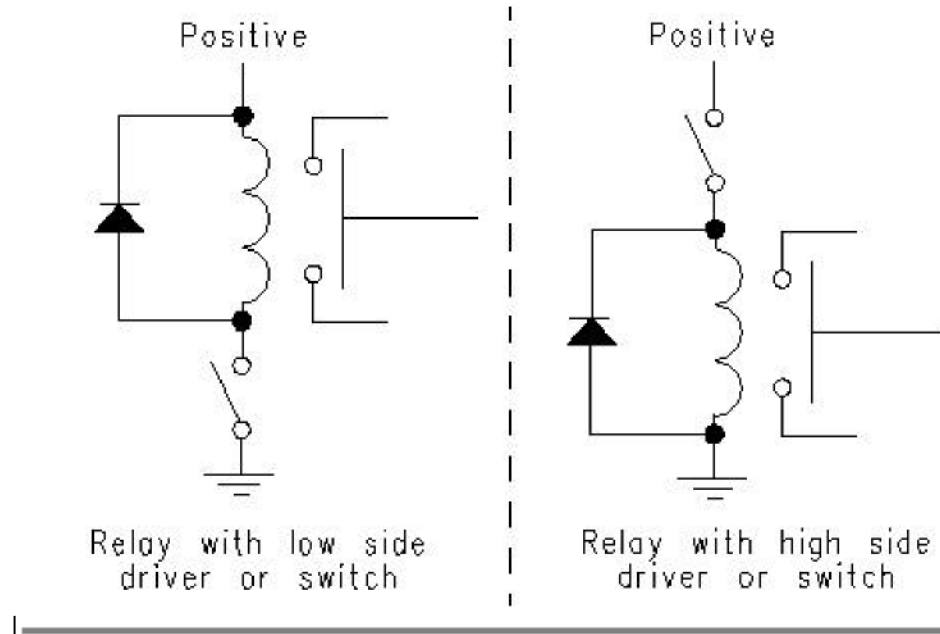

Relays and solenoids with built-in voltage transient suppression diodes are recommended whenever possible. Refer to the illustration for proper installation of diodes when built-in voltage transient suppression is not available.

Locate inductive devices as far as possible from the components of the electronic control system. When using electric motors it may also be necessary to add isolation relays to eliminate voltage transients, noise and prevent back feed.

## **Welding on Equipment with Electronic Controls**

Proper welding procedures are required to avoid damage to electronic controls, sensors and associated components. The component should be removed for welding if possible.

The following procedure must be followed if the component must be welded while installed on equipment with electronic controls. This procedure will minimize the risk of component damage.

### **Warning**

---

Do not ground the welder to electrical components such as the control ground or sensors!  
Improper grounding can cause damage to electrical components!

Clamp the ground cable from the welder to the component being welded.  
Place the clamp as close as possible to the weld to reduce the possibility of damage.

---

1. Stop the engine. Turn the key switch to the OFF position.
2. Disconnect the negative battery cable from the battery.
3. Open any installed battery disconnect switch.
4. Unplug the control system if possible.
5. Connect the welding ground cable as close as possible to the area to be welded.
6. Protect the wiring harness from welding debris and spatter.
7. Use standard welding methods to weld the materials.



## General Troubleshooting

For additional information, refer to engine manufacturer troubleshooting guide.

### No response from starter motor

Possible Cause	Possible Remedy
No battery voltage to starter	Verify wiring and battery connection (power and ground)
Battery discharged	Charge or replace battery, verify alternator charging
Tripped overcurrent protection	Correct fault, replace or reset overcurrent protection
No signal from control system	No power to control system (see <i>Control System Troubleshooting</i> )
Defective starter solenoid	Replace starter solenoid
Defective starter motor	Replace starter motor

### Engine will crank but not start

Possible Cause	Possible Remedy
Engine not getting fuel	Check fuel level, filter, fuel pump, verify no air in fuel lines
ECU is not functioning	See <i>Engine Troubleshooting</i>
Tripped overcurrent protection	Correct fault, replace or reset overcurrent protection
No preheat (cold condition)	See <i>Preheat Troubleshooting</i>

### Engine runs and shuts down

Possible Cause	Possible Remedy
ECU shutdown	Use display to view ECU diagnostic codes, use ECU diagnostic tool for more detailed information
Circuit overload protection tripped	Correct overload, keep control system from overheating (over 167° F or 75° C)
Voltage transients (spikes)	Add suppressor diodes, protect from nearby lightening strikes, shield induced spikes from other equipment, add electric motor control relay
Defective control system	See <i>Control System Troubleshooting</i>

### Alternator not charging battery

Possible Cause	Possible Remedy
Broken or slipping alternator drive belt	Adjust or replace alternator drive belt
Alternator not excited	Verify excitation circuit connected, replace faulty regulator
Alternator output not connected	Install charge wire
Alternator not grounded	Clean or add ground connection
Alternator faulty	Replace faulty alternator

## Engine Troubleshooting

### Note

Most problems with ECU controlled engines can be pinpointed via the ECU diagnostic messages. Use the display or ECU diagnostic tool to view fault codes.

All engine state information and diagnostic codes shown by the CANplus display are provided by the CANbus.

ECU programming determines the response to warnings and failures. Typically the ECU can be programmed to shutdown, derate or run to failure.

### ECU does not power-up

Possible Cause	Possible Remedy
No power to ECU	Locate reason for lack of power and correct (Circuit overloaded? Failed suppressor diode? Faulty wiring?)
Tripped overcurrent protection	Correct fault, replace or reset overcurrent protection
Faulty ECU	Replace ECU
Optional e-stop engaged	Disengage e-stop

### Engine not getting fuel

Possible Cause	Possible Remedy
Empty fuel tank	Fuel engine
Clogged filter	Replace filter
Air in fuel lines	Bleed fuel lines
Low fuel pressure	Replace faulty fuel pump and/or clogged filter
Faulty fuel pump	Replace fuel pump, correct wiring fault (electric fuel pump)

### Preheat Troubleshooting

#### Engine is hard to start in cold conditions

Possible Cause	Possible Remedy
Start attempt before preheat complete	Wait for preheat time to elapse, crank as soon as time elapses
Heater faulty	Replace heater
Heater relay faulty	Replace relay
Preheat control not functioning	Correct wiring, correct ECU configuration
Faulty control system	Repair or replace ECU

#### Engine produces excessive white smoke after starting

Possible Cause	Possible Remedy
Afterglow not enabled	Reconfigure ECU
Heater faulty	Replace heater
Heater relay faulty	Replace relay
Preheat control not functioning	Correct wiring, correct ECU configuration
Faulty control system	Repair or replace ECU

## Control System Troubleshooting

### Control system does not perform self test

Possible Cause	Possible Remedy
Tripped overcurrent protection	Correct fault, replace or reset overcurrent protection
Faulty connection to battery	Correct battery connections (see <b>Battery Circuit Requirements</b> )
Faulty control system	Repair or replace control system

### Control system performs normal self test, engine cranks, runs and shuts down

Possible Cause	Possible Remedy
Engine Stop LED illuminated	Correct ECU stop condition, use ECU diagnostics

### Display does not display data

Possible Cause	Possible Remedy
Display lost power	Turn on key, verify display plugged into harness
Engine Source address incorrect	Change Engine Address in Configuration
Display Address incorrect	Change Display Address to 40 (default)
Display configuration problem	Reset display using <b>Restore Defaults</b>
CANbus failure	Check CANbus (see <b>Testing CANbus</b> )
ECU not sending data	Repair or replace ECU

## Testing a Warning or Shutdown

Shutdown simulation with ECU controlled engines requires using the ECU diagnostic tool. Refer to the diagnostic tool documentation to simulate a warning or shutdown.

## Testing CANbus

Most information provided to the CANplus display is sent by the ECU via the CANbus. CANbus is an international data bus used to support SAE J1939. If this connection is broken or improperly terminated, the CANplus display cannot show ECU parameters such as engine hours, oil pressure and diagnostic codes. This test procedure helps identify the problem location.

1. Disconnect the battery.

### Warning

---

This test should be completed with the battery disconnected!

---

Failure to disconnect the battery may cause ECU, panel or test equipment damage!

---

2. Identify the engine diagnostic plug. Connect an ohmmeter across the CANbus pins of the diagnostic plug.
3. A reading of  $60\Omega$  indicates both ends of the bus are terminated and the bus is intact.
4. A reading of  $120\Omega$  indicates only one end of the bus is terminated. Identify the CANbus terminator on the engine harness and remove it.
  - a. An ohmmeter reading of  $120\Omega$  indicates the bus to the terminator in the panel is complete and the problem is between the panel and the engine terminator.
  - b. An open circuit ohmmeter reading indicates the bus to the engine terminator is complete and the problem is between the panel and the diagnostic plug.
5. Reinstall the terminator resistor and reconnect the battery.
  - a. If the ECU diagnostic tool is available, use it to verify the ECU is transmitting CANbus data. Refer to ECU documentation to identify and correct the error.
  - b. If another panel is available for testing, replace the panel to determine if the error is in the panel.

## Diagnostic Trouble Codes (DTC)

CANbus Diagnostic Trouble Codes are a pair of numbers; the Suspect Parameter Number (SPN) and Failure Mode Identifier (FMI). The SPN indicates the faulting subsystem and the FMI identifies the type of failure.

### Typical SPNs

Standard SPN codes are defined by SAE J1939-71. Not all standard codes are provided by ECUs. Manufacturers may add additional SPN codes beyond the codes identified in J1939-71. Refer to ECU documentation for supported SPNs.

SPN	Description
51	Throttle Position
91	Accelerator Pedal Position
94	Fuel Delivery Pressure
98	Engine Oil Level
100	Engine Oil Pressure
110	Engine Coolant Temperature
111	Coolant Level





























### FMI

FMI codes are defined by SAE J1939-71. Refer to ECU documentation for correct interpretation of FMI codes for a specific SPN.

FMI	Description
0	Data valid but above normal operational range
1	Data valid but below normal operational range
2	Data erratic, intermittent or incorrect
3	Voltage above normal or shorted high
4	Voltage below normal or shorted low
5	Current below normal or open circuit
6	Current above normal or grounded circuit
7	Mechanical system not responding properly
8	Abnormal frequency, pulse width or period
9	Abnormal update rate
10	Abnormal rate of change
11	Failure mode not identifiable
12	Bad intelligent device or component
13	Out of calibration
14	Special instructions
15	Data valid but above normal operational range (least severe)
16	Data valid but above normal operational range (moderately severe)
17	Data valid but below normal operational range (least severe)
18	Data valid but below normal operational range (moderately severe)
19	Received network data in error
20	
thru	Reserved for future assignment
30	
31	Not available or condition exists

## Data Parameters Monitored

This table lists the engine and transmission parameters that are monitored via the CANbus. The parameters can be displayed by the user-configurable gauge pages or the single analog gauge. DB is an abbreviation for the internal database which stores all data transmitted from the engine/transmission. The complete database can be accessed on the display via the Configuration menu.

Icon	Parameter	Gauge Pages	Single Analog	Database
<b>Electrical (Volts or Amps)</b>				
	Electrical Potential	●	●	●
	Battery Potential Switched	●	●	●
	Net Battery Current	●	●	●
	Alternator Potential	●	●	●
	Alternator Current	●	●	●
<b>Fuel (L, Gal, lGal) or (L/h, Gal/h lGal/h) or (km/L, MPG or IMPG)</b>				
	Fuel Remaining	●		●
	Fuel Rate	●	●	●
	Instantaneous Fuel Economy	●		●
	Trip Fuel Economy	●		●
	Trip Fuel	●		●
	Trip Fuel Rate	●		●
	Total Fuel Used	●	●	●
	Fuel Leakage 1			●
	Fuel Leakage 2			●
<b>Distance (km, Miles or Nmiles)</b>				
	Distance Remaining	●		●
	Trip Distance	●		●
	Total Vehicle Distance	●		●
<b>Pressure (kPa, PSI or bar)</b>				
	Fuel Delivery Pressure	●	●	●
	Barometer Pressure	●		●
	Auxiliary Pressure 1	●		●
	Boost Pressure	●	●	●
	Air Inlet Pressure	●		●
	Air Filter 1 Differential Pressure	●		●
	Injector Metering Rail 1 Pressure			●
	Injector Metering Rail 2 Pressure			●
	Coolant Pressure	●	●	●
	Engine Oil Pressure	●	●	●
	Transmission Oil Pressure	●	●	●
	Clutch Pressure			●
	Air Start Pressure			●
	Injection Control Pressure			●
<b>Temperature (°C or °F)</b>				
	Engine Coolant Temperature	●	●	●
	Engine Intercooler Temperature	●		●
	Engine Oil Temperature 1	●	●	●
	Transmission Oil Temperature	●	●	●
	Turbo Oil Temperature	●		●

Icon	Parameter	Gauge Pages	Single Analog	Database
	Fuel Temperature	●	●	●
	Intake Manifold 1 Temperature	●	●	●
	Air Inlet Temperature	●		●
	Exhaust Gas Temperature	●	●	●
	Auxiliary Temperature 1	●		●
	Engine ECU Temperature			●
	Exhaust Gas Port 1 Temperature			●
	Exhaust Gas Port 2 Temperature			●
	Turbo 1 Compressor Inlet Temperature			●
<b>Percentage (%)</b>				
	Fuel Level	●		●
	Acceleration Position	●	●	●
	Throttle Position			●
	Engine Oil Level	●		●
	Coolant Level	●		●
	Estimated Percent Fan Speed	●		●
	Drivers Demand Percent Torque	●		●
	Actual Engine Percent Torque	●	●	●
	Torque Use at RPM	●	●	●
<b>Speed (RPM, km/h, MPH or KTS)</b>				
	Input Shaft Speed			●
	Output Shaft Speed			●
	Engine Speed	●	●	●
	Turbo 1 Speed			●
	Engine Desired Operating Speed			●
	Navigation Wheel Based Vehicle Speed	●		●
<b>Time (h)</b>				
	Total Engine Hours	●		●
	Trip Engine Hours	●		●
	Service Hours			●
<b>Miscellaneous</b>				
	Torque Converter Lock-Up Engaged			●
	Current Gear	●		●
	Selected Gear	●		●
	CANTX Disable			●

## Abbreviations

The units *MPG* and *Gal* denote US gallons. For non-US US gallons (UK, Canada, etc) the units are denoted as *IMPG* or *IGal*. *N* denotes nautical miles. *KTS* denotes knots.

## Note

---

If a parameter is not available it will not be possible to select it.  
 If a parameter becomes unavailable while in view **---** is displayed.

---

## **Glossary**

CAN	Controller Area Network (also referred to as CANbus); serial communications protocol for electronic engines use
DTC	Diagnostic Trouble Code; the combination of SPN and FMI that identifies a specific error
ECU	Engine Control Unit; electronic device responsible for controlling and monitoring engine operation
FMI	Failure Mode Identifier; defines the type of failure detected in the subsystem identified by the SPN
GPS	Global Positioning System; a system of satellites and receiving devices used to compute positions on the earth, used in navigation
ISO	International Standard Organization; an international organization working with the United Nations that maintains technology standards for global industry
J1939	SAE engine data protocol using CAN 2.0B
LCD	Liquid Crystal Display; a display technology that uses electric current to align crystals in a special liquid. When current is applied the crystals change their orientation creating a darker area.
NMEA	National Marine Electronics Association, serial communications protocol for marine use
RS-232	Standard electrical interface for serial communications
RS-485	Standard differential electrical interface for serial communications
SAE	Society of Automotive Engineers; professional association of transportation industry engineers that sets most auto-industry standards for the testing, measuring, and designing of automobiles and their components
Soft buttons	Push buttons whose function changes according to use
SPN	Suspect Parameter Number; a number used to identify a particular element, component or parameter associated with an ECU

### **Note**

---

The messages, icons and error codes displayed conform to J1939 standards wherever possible.

A copy of the relevant standards documents may be accessed and purchased at:  
<http://www.sae.org/standardsdev/groundvehicle/j1939a.htm>

---



## **Software Revision History**

### **1.30**

- Initial release

## **Document Revision Information**

Initial: 24-Jul-2007.

## **Typical Schematic**

---

The following page shows a typical schematic.  
Details vary from installation to installation.  
See the specific schematics for installation for details.

---

# CANplus 600 Control Panel Operation and Troubleshooting

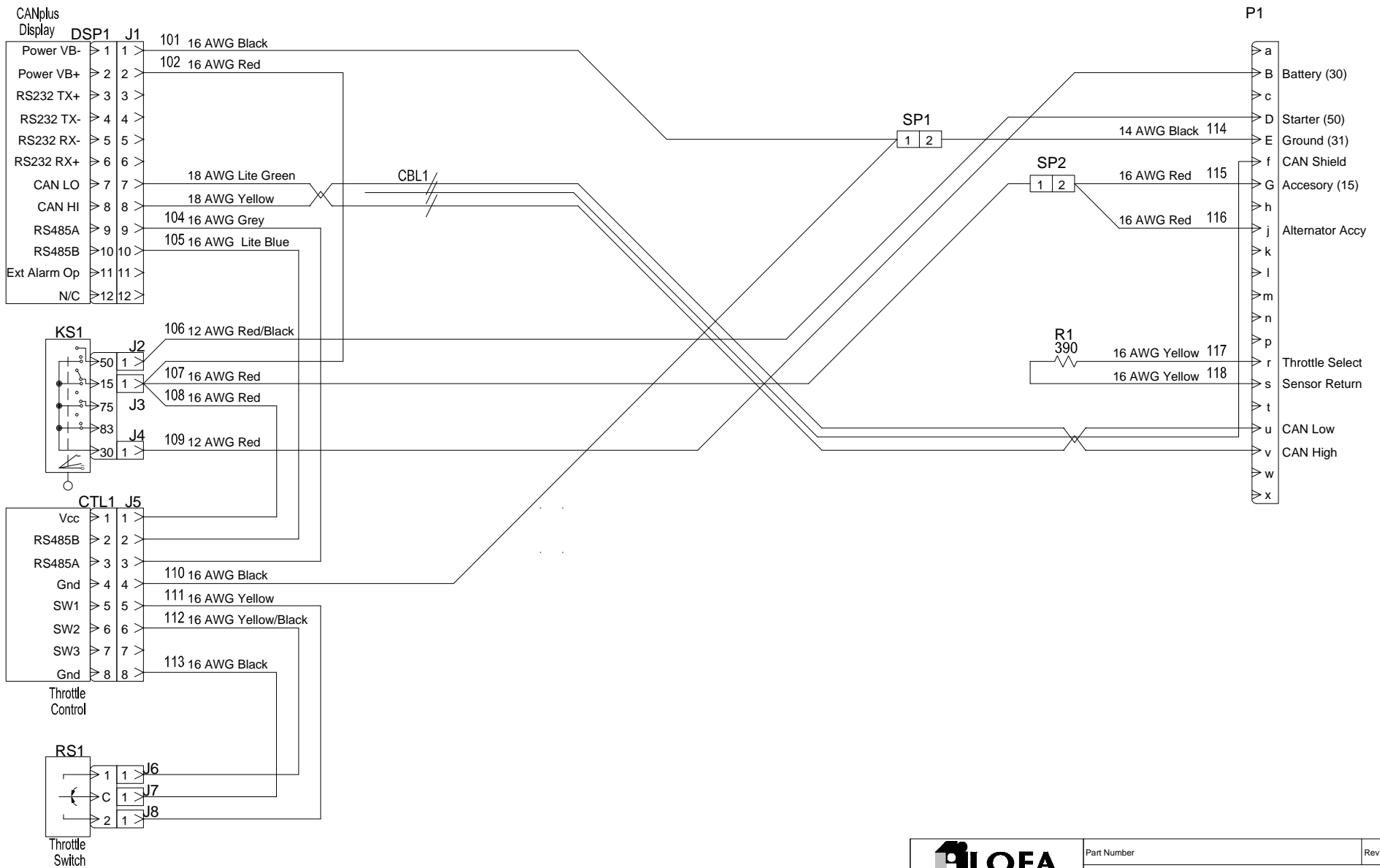

©THE INFORMATION CONTAINED IN THIS DRAWING IS CONFIDENTIAL AND THE SOLE PROPERTY OF LOFA INDUSTRIES INC. Reproduction or dissemination in whole or in part in any form or medium without express prior written permission of LOFA INDUSTRIES INC is prohibited. All rights of design reserved

<p>MANUFACTURER OF QUALITY ENGINE COMPONENTS WWW.LOFA.COM</p> <p>250 Hembree Park Dr Ste 122 Roswell GA 30076 Phone: 770-569-9626 Fax: 770-569-9629</p>	Part Number	Rev
	Description CP600 Generic Point to Point	
	Date 7/24/2007	Sheet of



250 Hembree Park Drive, Suite 122, Roswell, GA 30076

TEL 770-569-9828 FAX 770-569-9829 | [www.LOFA.net](http://www.LOFA.net)

463-3000-07 Initial - 24-Jul-2007